

QUALITY FIREPLACES

24 Napoleon Road. Barrie, Ontario, Canada L4M 0G8 Tel: 705-721-1212 Fax: 705-722-6031

Electronic Ignition Service Manual

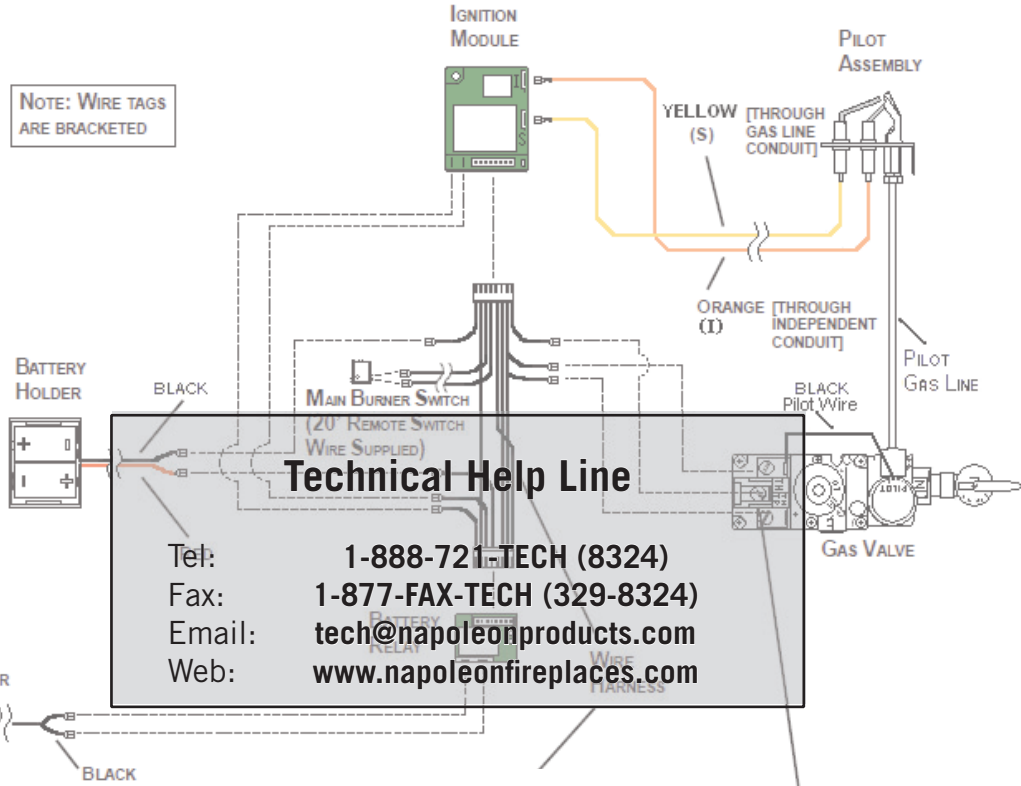

Technical Help Line

Tel: 1-888-721-TECH (8324)
 Fax: 1-877-FAX-TECH (329-8324)
 Email: tech@napoleonproducts.com
 Web: www.napoleonfireplaces.com

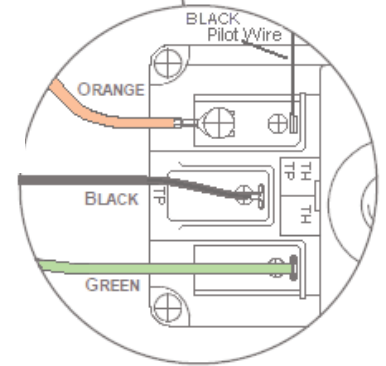
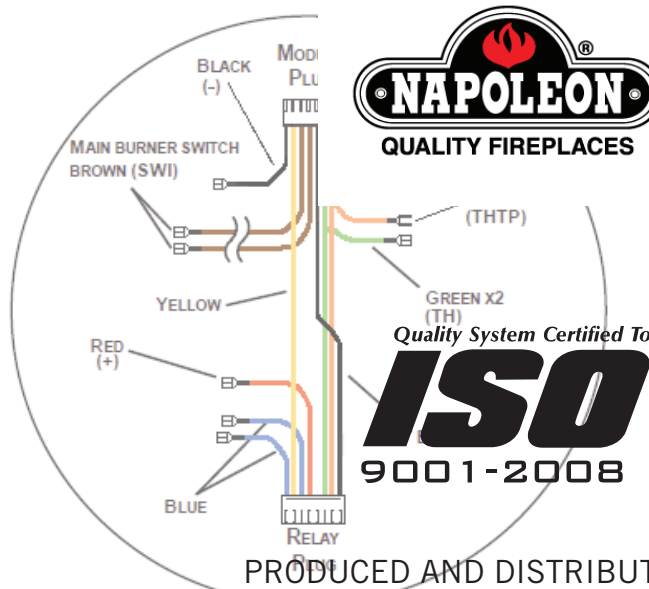

PRODUCED AND DISTRIBUTED BY:



© 2011 WOLF STEEL LTD.

ALL RIGHTS RESERVED, NO PART OF THIS BOOK MAY BE REPRODUCED IN ANY FORM OR BY ANY MEANS - GRAPHIC, ELECTRONIC OR MECHANICAL WITHOUT PRIOR WRITTEN PERMISSION FROM WOLF STEEL LTD., BARRIE, ONTARIO, CANADA



Wolf Steel's Electronic Ignition Service Manual Index

Tools Required For Testing4

Part 1: Troubleshooting: Dexen Valve Electronic Ignition

Dexen Valve Wiring Diagram.....	6
Pilot Not Sparking and/or Not lighting Flowchart.....	7
Pilot Not Sparking Test Pages.....	8 to 9
Pilot Not Lighting Test Pages.....	10 to 11
Main Burner Not Lighting Flowchart.....	12
Main Burner Not Lighting Test Page.....	13
ACS-1 Anti Condensation Switch Dexen Valve Troubleshooting Wiring Diagram.....	14
ACS-1 Anti Condensation Switch Dexen Valve Troubleshooting Page.....	15

Part 2: Troubleshooting: Proflame - S.I.T. with Stepper Motor Valve Electronic Ignition.

Proflame Valve Wiring Diagram.....	17
Pilot Not Sparking and/or Not lighting Flowchart.....	18
Pilot Not Sparking Test Pages.....	19 to 22
Pilot Not Lighting Test Pages.....	23
Main Burner Not Lighting Flowchart.....	24
Main Burner Not Lighting Test Page.....	25

Part 3: Troubleshooting: S.I.T. Manual Valve Electronic Ignition

S.I.T. Manual Valve Wiring Diagram.....	27
Pilot Not Sparking and/or Not lighting Flowchart.....	28
Pilot Not Sparking Test Pages.....	29 to 30
Pilot Not Lighting Test Pages.....	31
Main Burner Not Lighting Flowchart.....	32
Main Burner Not Lighting Test Page.....	33

© WOLF STEEL LTD

ALL RIGHTS RESERVED, NO PART OF THIS BOOK MAY BE REPRODUCED OR TRANSMITTED IN ANY FORM OR BY ANY MEANS-GRAPHIC, ELECTRONIC OR MECHANICAL WITHOUT THE PRIOR WRITTEN PERMISSION FROM WOLF STEEL LTD. BARRIE, ONTARIO, CANADA



Gas Fireplaces

Electronic Ignition Troubleshooting

DSI SYSTEM

- Direct spark ignition system
- Control module responds to heat demand from the thermostat or switch by generating high voltage, low current electrical pulses
- These pulses are transmitted from the control module to the spark electrode.
- As the control module is generating sparks it also powers the 24 vac gas control valve to allow gas to flow for about 4-7 seconds.
- If the main burner ignites within the 4-7 second ignition try, the control module generates a small electrical current that passes from the flame rod through the flame to the burner it is now converted to DC Microamps by flame rectification and then is grounded back to the control module. When the flame is sensed by this signal, the control module stops generating sparks. As long as this signal returns to the control module, the module powers the gas control valve to continue gas flow.

TOOLS NEEDED FOR TESTING

MULTI METER

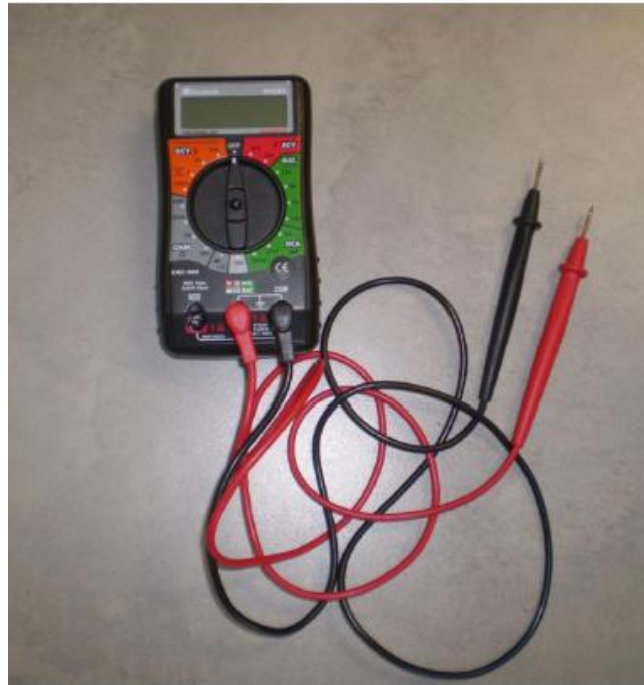

MANOMETER-LOW GAS FLOW PRESSURE GAUGE

DIGITAL STYLE GAUGE



SPRING STYLE GAUGE



DEXEN EI SYSTEM

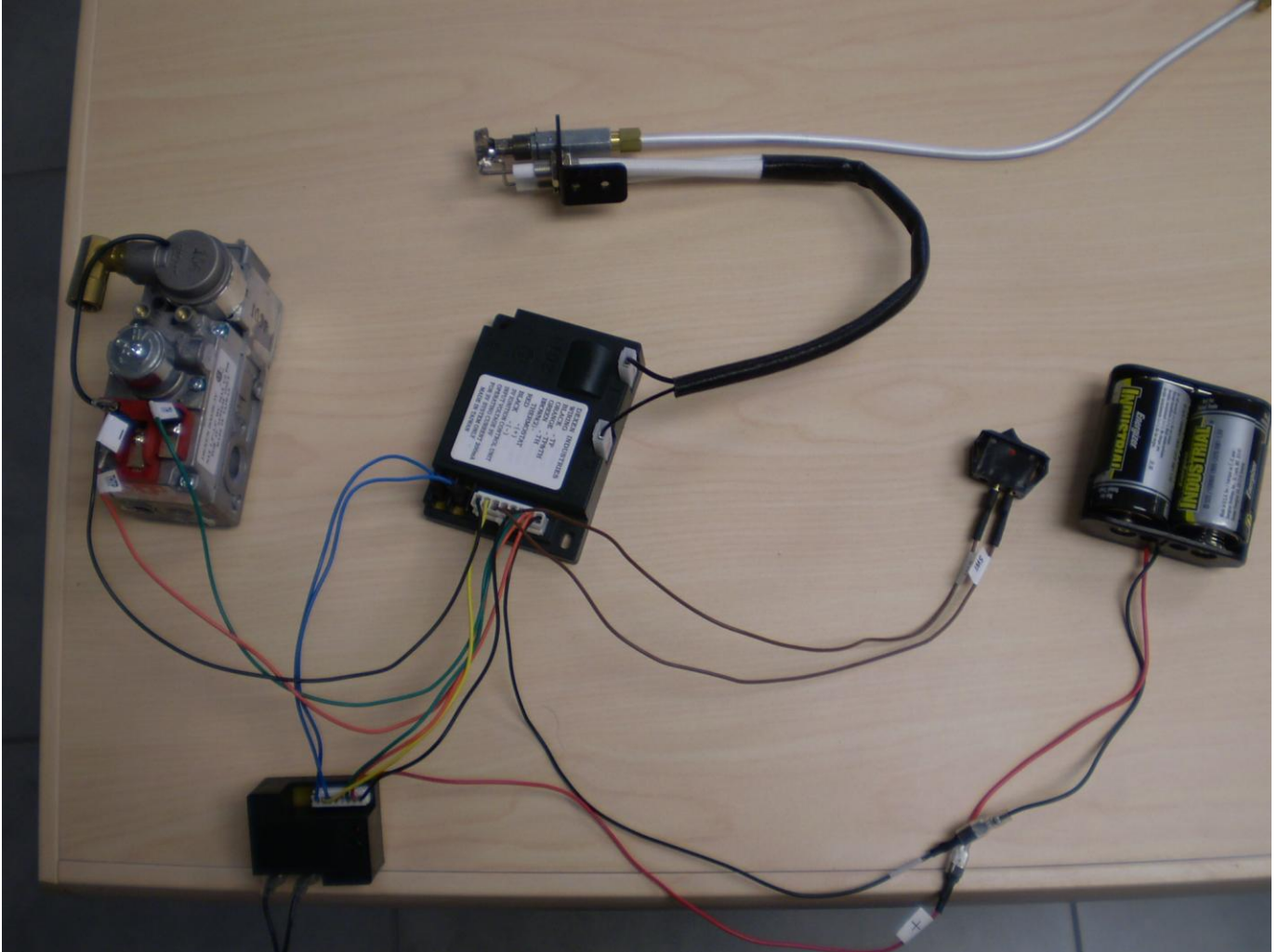

DEXEN PILOT ASSEMBLY



DEXEN VALVE



DEXEN IGNITION CONTROL MODULE

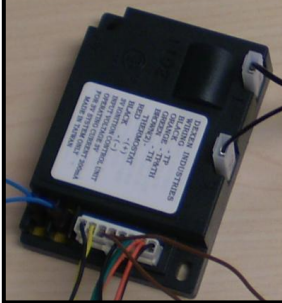

DEXEN BATTERY RELAY



DEXEN BACKUP BATTERY PACK



DEXEN VALVE WIRING DIAGRAM

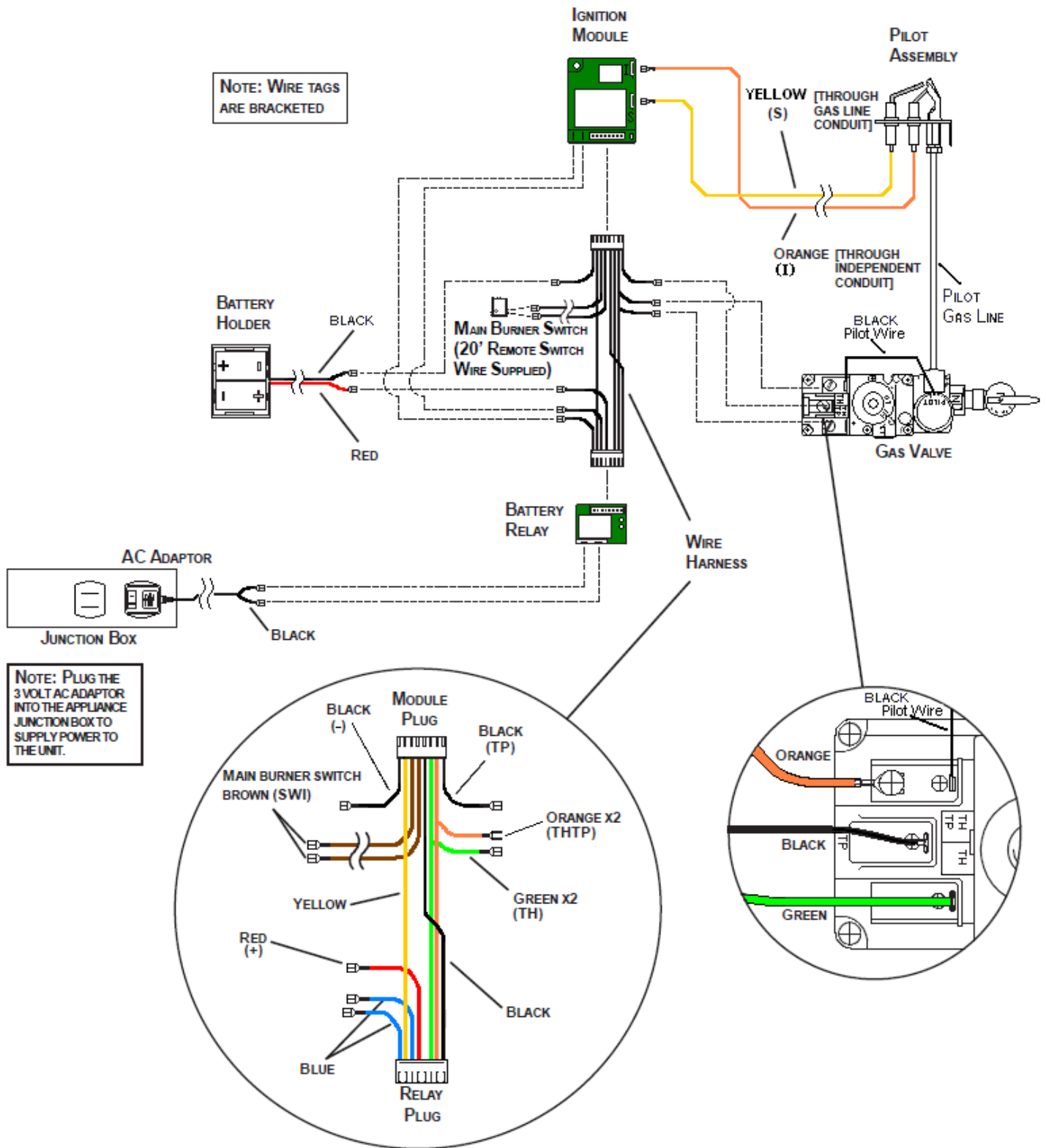

Troubleshooting: Dexen Valve Electronic Ignition Units Pilot Not Sparking And / Or Lighting Flowchart

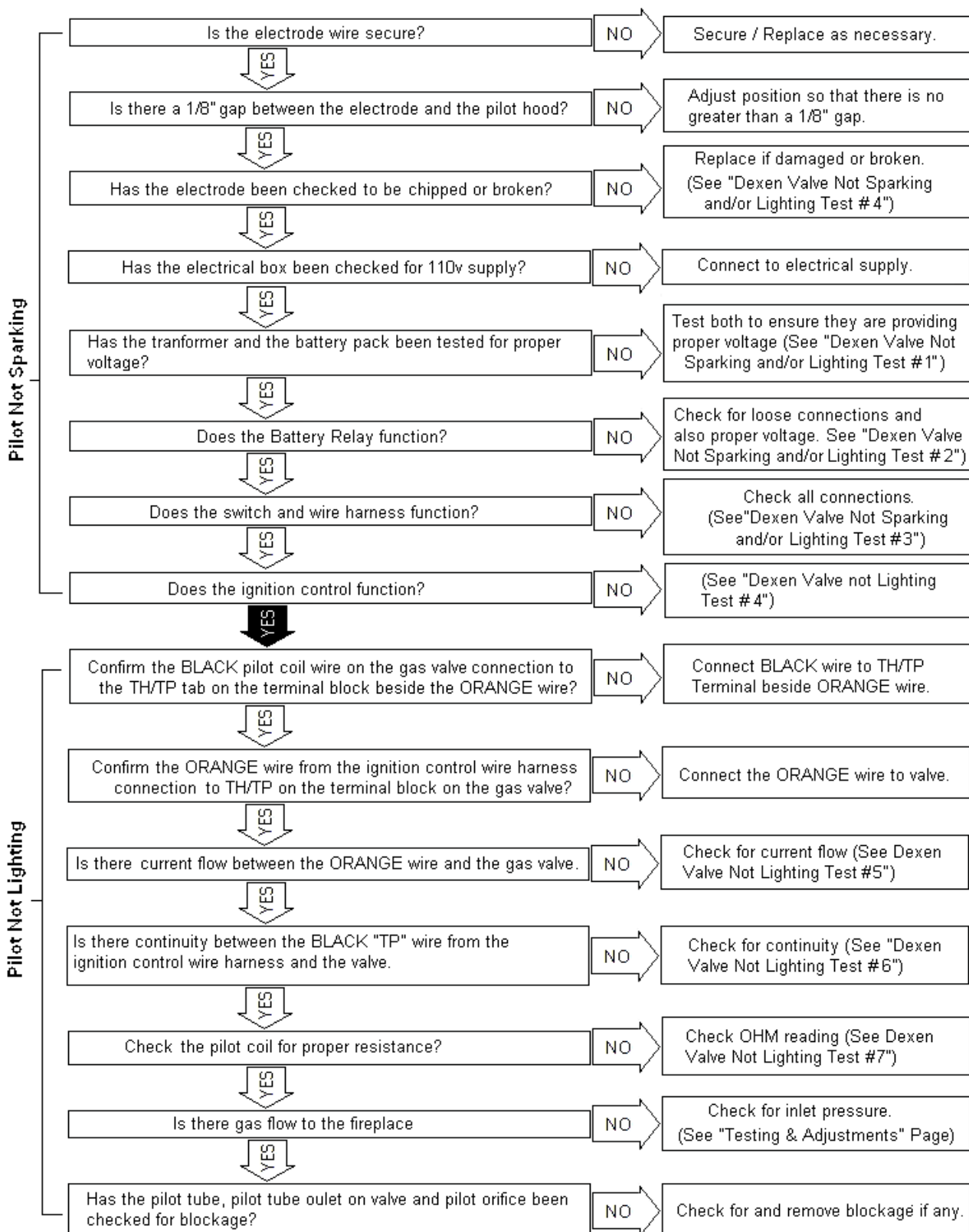

DEXEN VALVE ELECTRONIC IGNITION NOT SPARKING DIAGNOSTICS TEST

NOTE: BEFORE STARTING THIS TEST CONFIRM THAT ALL WIRE CONNECTIONS ARE GOOD

(A)



TEST #1 – Test for 2.8 to 3.4 AC volt power supply from either the plug in transformer and/or the 2x D size battery backup depending on what component is being used to power the system.

STEP #1- If using the transformer, test that there is between 2.8 to 3.4 AC volts output (A).

If no, replace transformer.

If yes, got to TEST #2

(B)



STEP #2- If using the battery backup, ensure that the batteries are producing 1.5 volts each.

Test that there is between 2.8 to 3.4 AC volts output from the battery pack wires (B).

If no, replace battery pack housing.

If yes, go to TEST #2

TEST #2 – Confirm that the Battery Relay is sending the correct current to the ignition control module.

STEP #1-First remove the wire harness from the battery relay and test that there is between 2.8 to 3.4 AC volts on the #1 & #3 pins on the battery relay using a multi meter set on 200AC volts (B).

If no, replace the battery relay.

If yes, go to STEP #2.

STEP #2-Reconnect the wire harness to the battery relay and test the ends of the 2 blue wires on the harness assembly. You should get between 2.8 to 3.4 AC volts (C).

If no, replace wire harness.

If yes, go to TEST #3.

(A)

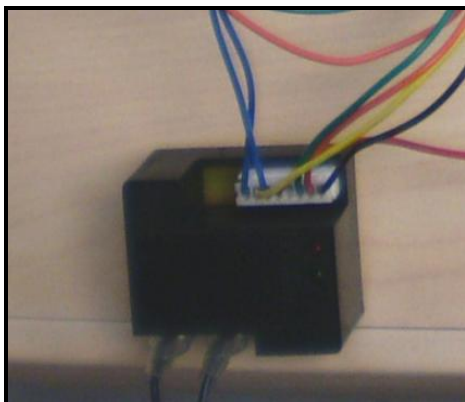

(B)



(C)



DEXEN VALVE ELECTRONIC IGNITION NOT SPARKING DIAGNOSTICS TEST - continued

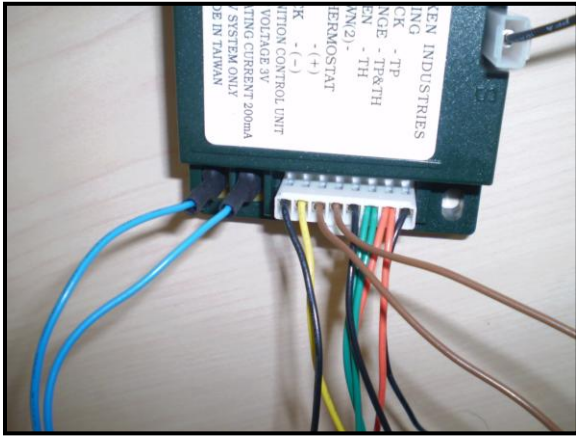

TEST #3 – Confirm that the wire harness connection on ignition control module is correct (see picture).

STEP #1-Connect the 2 brown wires marked “SWI” together to confirm pilot is sparking.

If yes, check the connections between Brown SWI wires from the wire harness and the switch, remote or thermostat, including the wiring used to connect between them.

If no, go to TEST #4.

TEST #4 – Confirm that the ignition control module and the spark electrode are functioning.

STEP #1-Remove wire harness off the ignition control module (A).

STEP #2-Use a jumper wire and jump pins #3 and #4 on the ignition control module (B).

If the pilot assembly starts sparking, replace wire harness.

If no, go to STEP #3.

STEP #3-Repeat the same test, but you will also have remove the igniter wire off the tab on the ignition control module and hold the igniter wire 1/8” away from the igniter tab to check for spark (C).

If no, replace ignition control module.

If yes, go to STEP #4.

STEP #4-Check that the gap between the ceramic electrode and the pilot hood is 1/8th inch.

If no, adjust the electrode to have the 1/8th inch gap to the pilot hood.

If yes, the ceramic electrode is cracked and the pilot assembly needs replacing.

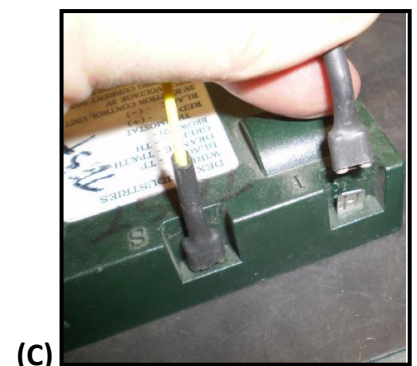
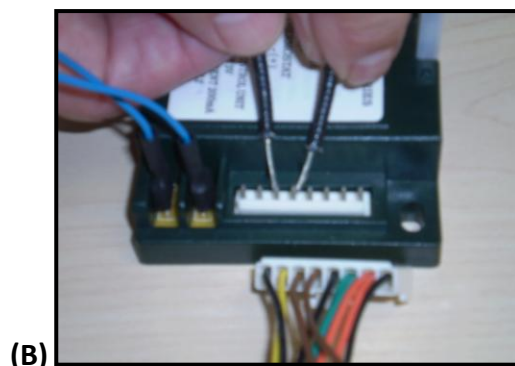

DEXEN VALVE ELECTRONIC IGNITION PILOT NOT LIGHTING DIAGNOSTICS TEST

TEST #5 – Confirm continuity and current flow from the ignition control to the gas valve.

STEP #1-Set your multi meter to 10A and plug the red probe into the 10A unfused connection. Place the tip of the BLACK meter lead on the TPTH tab onto the gas valve terminal block. Place the tip of the RED lead onto the tab on the end of the orange wire of the ignition control wire harness **(A)**. Active the unit to start ignition. Once the pilot starts sparking you should be reading a cycling amperage between 0.03 to 0.07.

NOTE: Once the pilot is operational it will have a current flow of 0.02 amps.

If “YES, go to TEST #6.

If “NO”, go to STEP #2.

STEP #2 – Set your multi meter for continuity. Remove the wire harness from the control module and remove the orange wire from the valve. Put 1 meter lead on the connector at the end of the orange wire and place the other meter lead on the metal connector that the two orange wires are plugged into on the wire harness pin connector **(B)**.

If no, replace wire harness.

If yes, go to STEP #3.

STEP #3 – Remove wire harness from battery relay and place one meter lead to on the metal connector that the orange wire is attached to on the small pin assembly and place the other meter lead on the metal connector that the two orange wires are attached to on the large pin assembly **(C)**.

If no continuity, replace wire harness.

If yes go to STEP #4

STEP #4 – Set your multi meter to 10A and plug the red probe into the 10A unfused connection. . Place the tip of the BLACK meter lead onto the end of the black TP wire from the ignition control wire harness. Place the tip of the RED lead onto the TP tab on the terminal block of the gas valve **(D & E)**. You should be reading 0.04 Amps.

If “YES, go to TEST #6.

If “NO”, go to STEP #5.

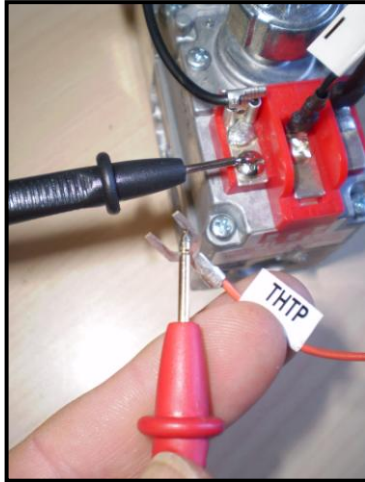

(A)

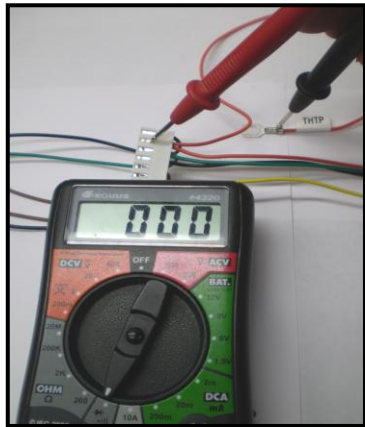

(B)

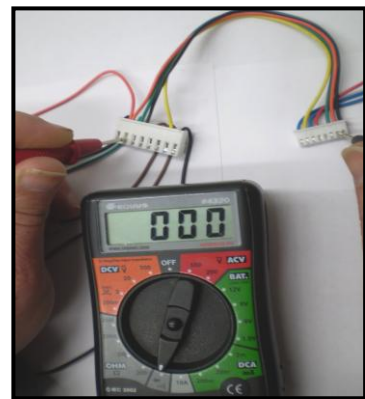

(C)



(D)

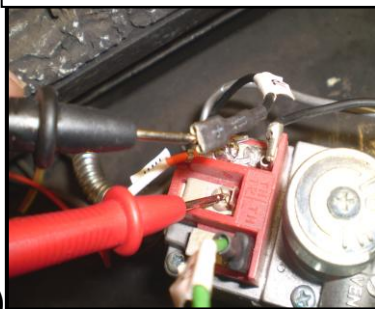

(E)

DEXEN VALVE ELECTRONIC IGNITION PILOT NOT LIGHTING DIAGNOSTICS TEST – continued



STEP #6 - Set your multi meter for continuity. Remove the wire harness from the control module and remove the black (TP) wire from the valve. Put 1 meter lead on the connector at the end of the black wire and place the other meter lead on the metal connector that the black wire is plugged into on the wire harness pin connector.

If no, replace wire harness.

If yes, go to TEST #6.



TEST #7 – Set your multi meter to 200 OHMS and place the tip of the red meter lead on or in the connector at the end of the pilot coil wire (as shown in the picture). Place the tip of the black meter lead to the body of the valve (as shown in the picture). You should be getting between 37 to 40 OHMS.

If no, replace gas valve.

If yes, check inlet pressure test port for gas flow to Valve (see “Testing & Adjustments Section”).

If there is gas flow, check for blockage in pilot orifice, pilot tube, and pilot connection port on valve. Remove blockage where found.

If no gas to valve, inspect supply lines and shut off valves.



Troubleshooting: Dexen Valve Electronic Ignition Units Burner Not Lighting Flowchart

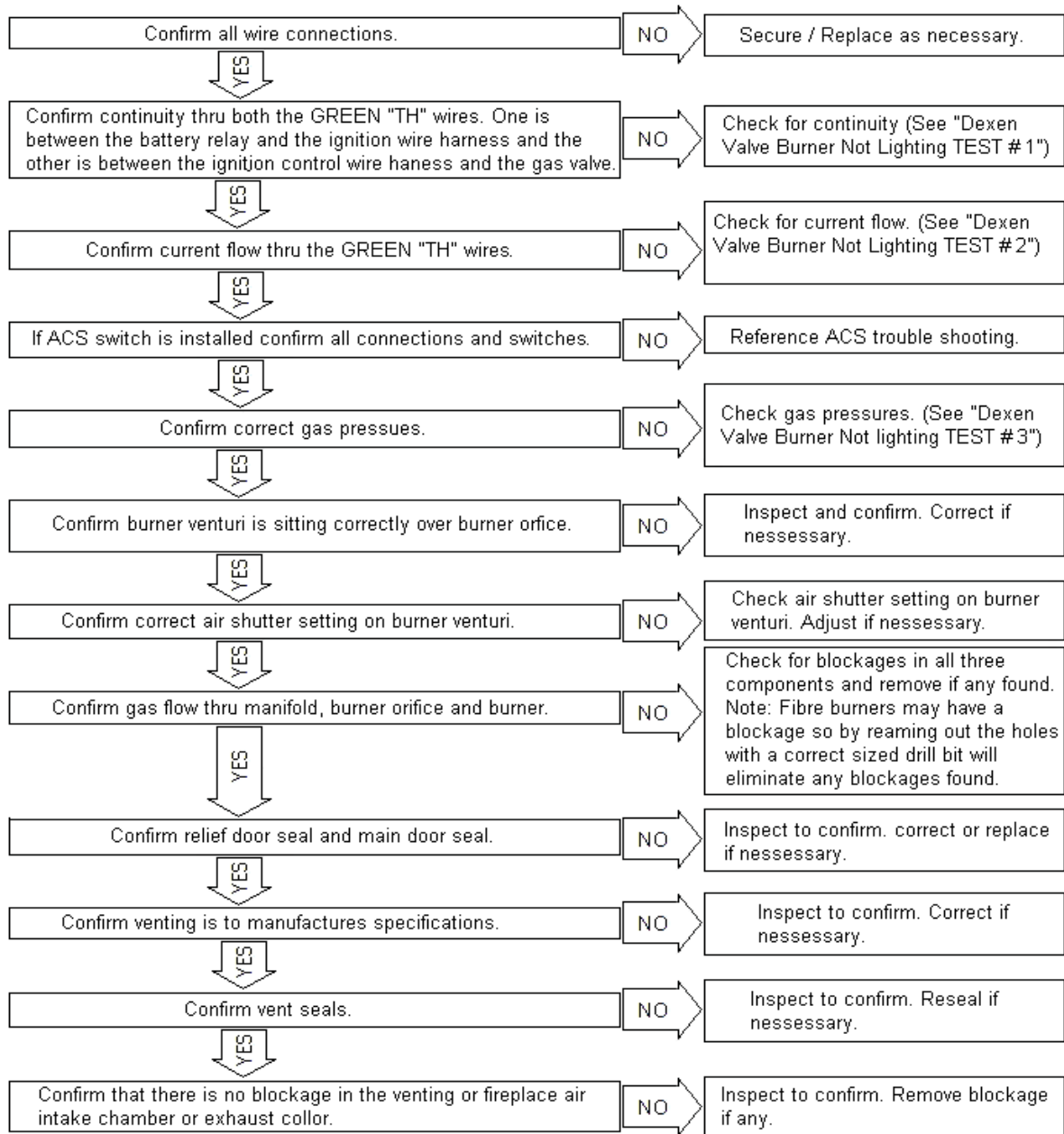

DEXEN VALVE ELECTRONIC IGNITION BURNER NOT LIGHTING DIAGNOSTICS TEST

NOTE: BEFORE STARTING THIS TEST CONFIRM THAT ALL WIRE CONNECTIONS ARE GOOD

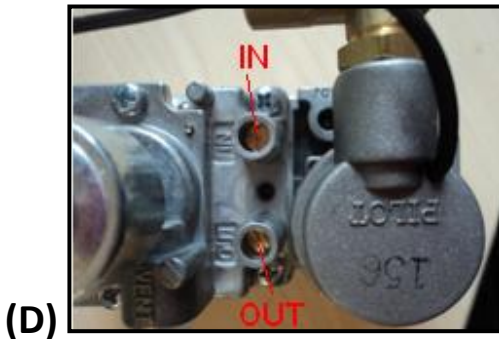
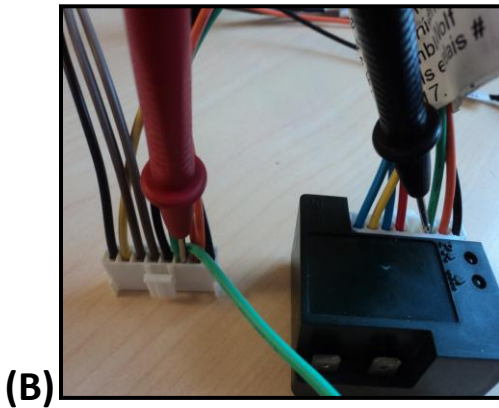
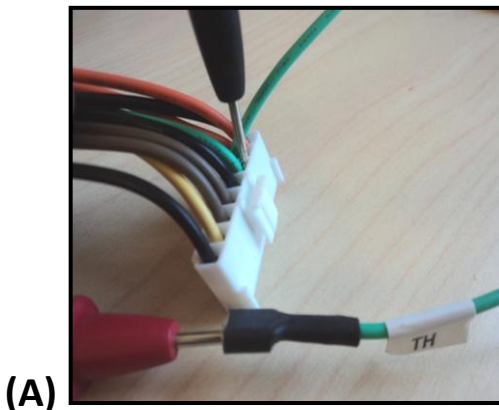

TEST #1 – Confirm continuity thru both GREEN wires from the Battery Relay to the Ignition control wire harness, and from the Ignition control to the gas valve pilot coil **(A)**.

STEP #1 – Place the BLACK probe lead into where the green wires come out of the wire harness connection, and place the RED probe lead into the end of the green (TH) wire tab connection.

If “YES” go to STEP #2

If “NO”, replace wire harness.

STEP #2 – place the BLACK probe lead into where the green wire is connected in the plug connection at the Battery Relay. Place the RED probe lead into where the double green wires are connected in the plug connection for the Ignition module **(B)**.

If “YES”, go to TEST #2.

If “NO”, replace the wire harness.

TEST #2 – Confirm current thru green (TH) wire to the (TH) tab on the gas valve.

NOTE: Pilot light must be running in order to perform this test.

STEP #1 – Place your RED meter lead probe onto the end of the green (TH) wire from wire harness. Place your BLACK meter lead probe onto the (TH) tab of the gas valve. You should be getting between .03 Amps **(C)**.

If “YES”, go to Test #3.

If “NO”, replace ignition module.

NOTE – Confirm correct pressure to and out of gas valve.

STEP #1 – Check inlet pressure (IN) should be 7”wc for natural gas and 11”wc to 13”wc for propane.

If “NO”, check supply lines and meter (NG)/regulator (LP)

If “YES”, Go to STEP #2.

STEP #2 – Check outlet pressure (OUT) should be 3.5”wc on high for natural gas and 10”wc for propane.

If “NO”, confirm if a conversion was done that it was done correctly. If it was done correctly, then replace gas valve.

ACS-1 ANTI CONDENSATION SWITCH FOR DEXEN ELECTRONIC IGNITION TROUBLE SHOOTING

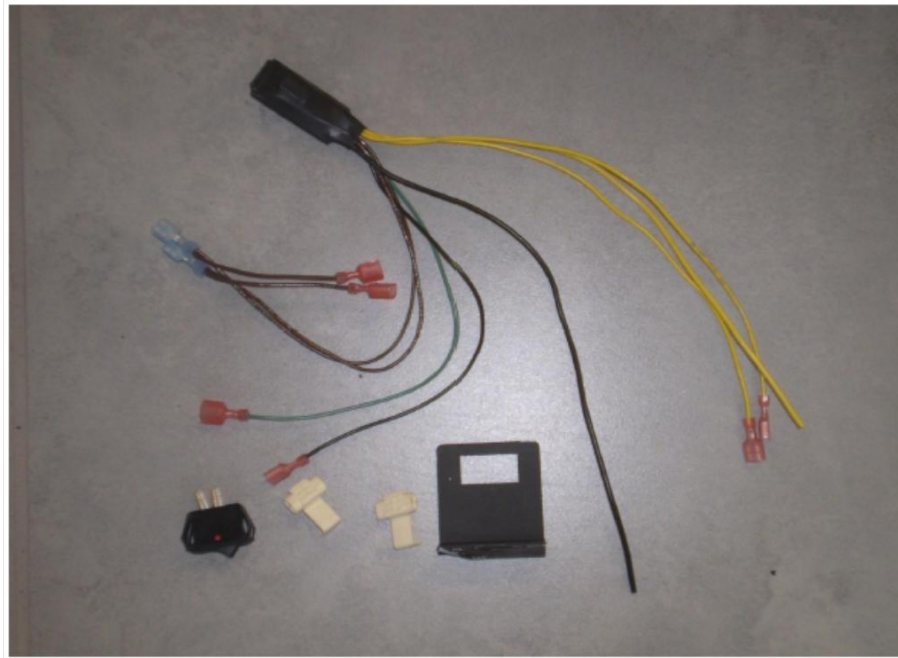

ACS-1 TO DEXEN VALVE WIRING DIAGRAM

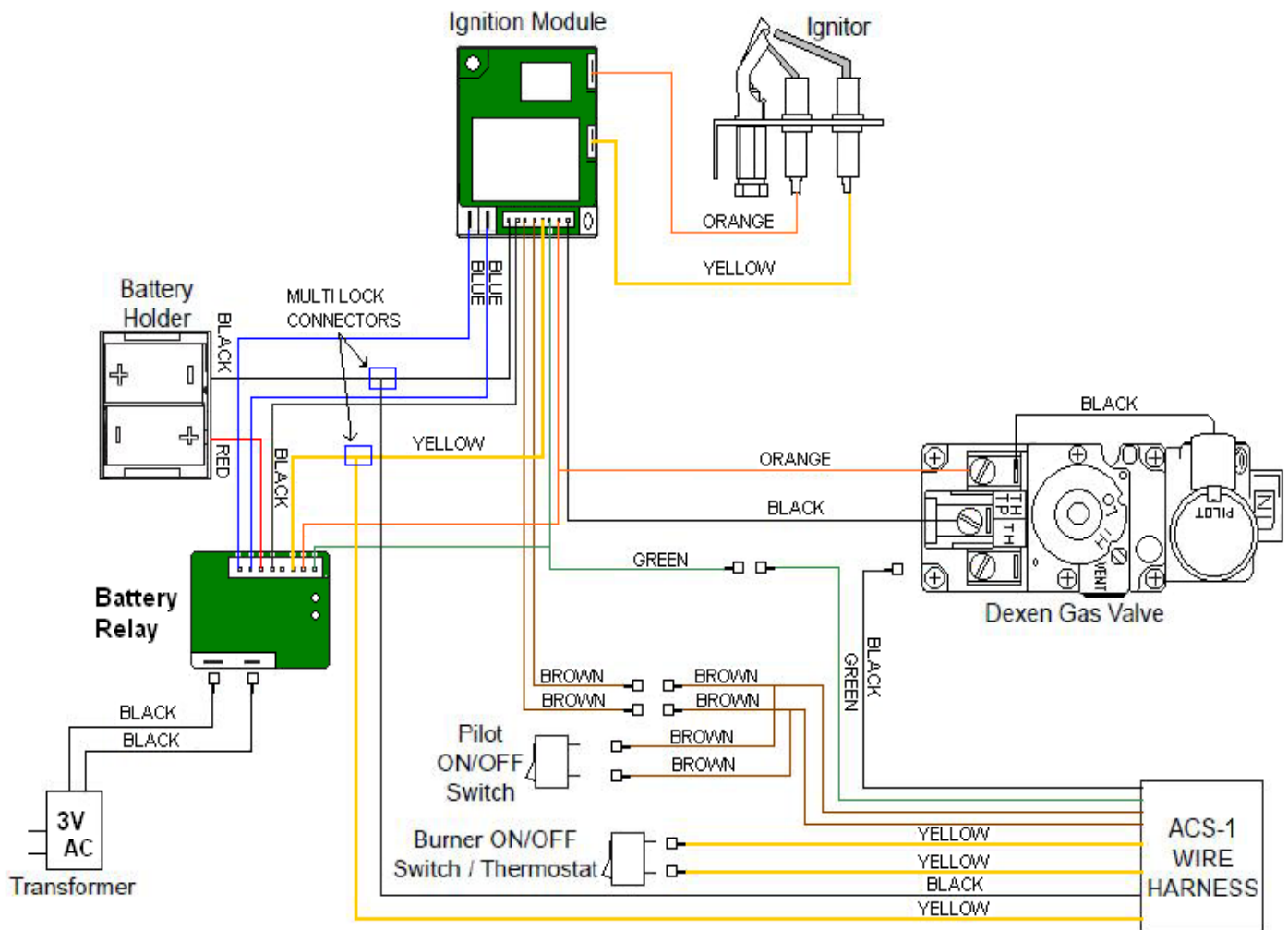

TROUBLESHOOTING

SYMPTOM	PROBLEM	TEST SOLUTION
Pilot will not light	Wiring	<p>Remove ASC-1 connections and reconnect the original fireplace wire harness to their correct connections and test to see if the unit operates normally.</p> <p>If “YES” reconnect the ACS-1 and check all connections. Ensure that both the BLACK & YELLOW power connections are secure and making good contact to both the BLACK & YELLOW wire on the ignition control wire harness and that there is between 2.8 to 3.4 AC volts going thru them.</p> <p>If “NO”, refer to Dexen valve trouble shooting pages</p> <p>Check for any shorted or broken wires. Perform a continuity test on all ACS-1 wires.</p> <p>If “YES”, that a wire is broken where there is no continuity then replace the ACS-1.</p> <p>If “NO” disconnect the pilot ON/OFF switch from the 2 BROWN wires and jumper the brown wires to see if the pilot lights.</p> <p>If “YES”, replace switch.</p> <p>If “NO”, replace the ACS-1.</p>
Pilot lights, but burner will not light	Wiring	<p>Check wire connections, if loose reconnect. If burner will not come on disconnect the burner ON/OFF (switch, remote or thermostat), and jumper the two yellow wires. If “YES” replace (switch, remote or thermostat). If “NO”, replace the ACS-1.</p>

PROFLAME – S.I.T. VALVE with STEPPER MOTOR ELECTRONIC SYSTEM

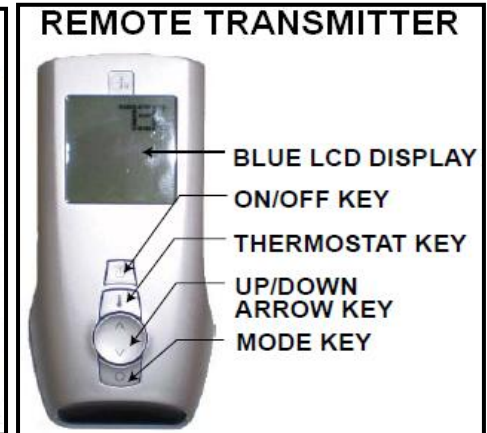
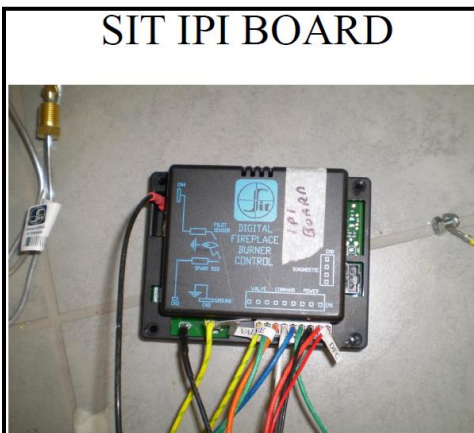
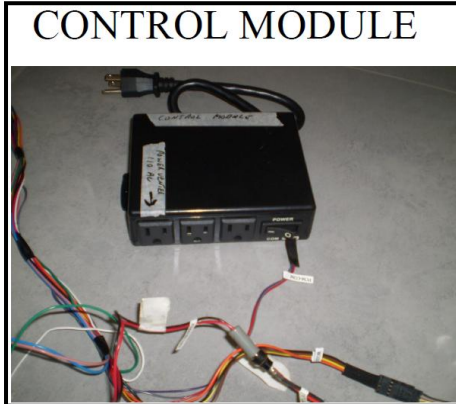
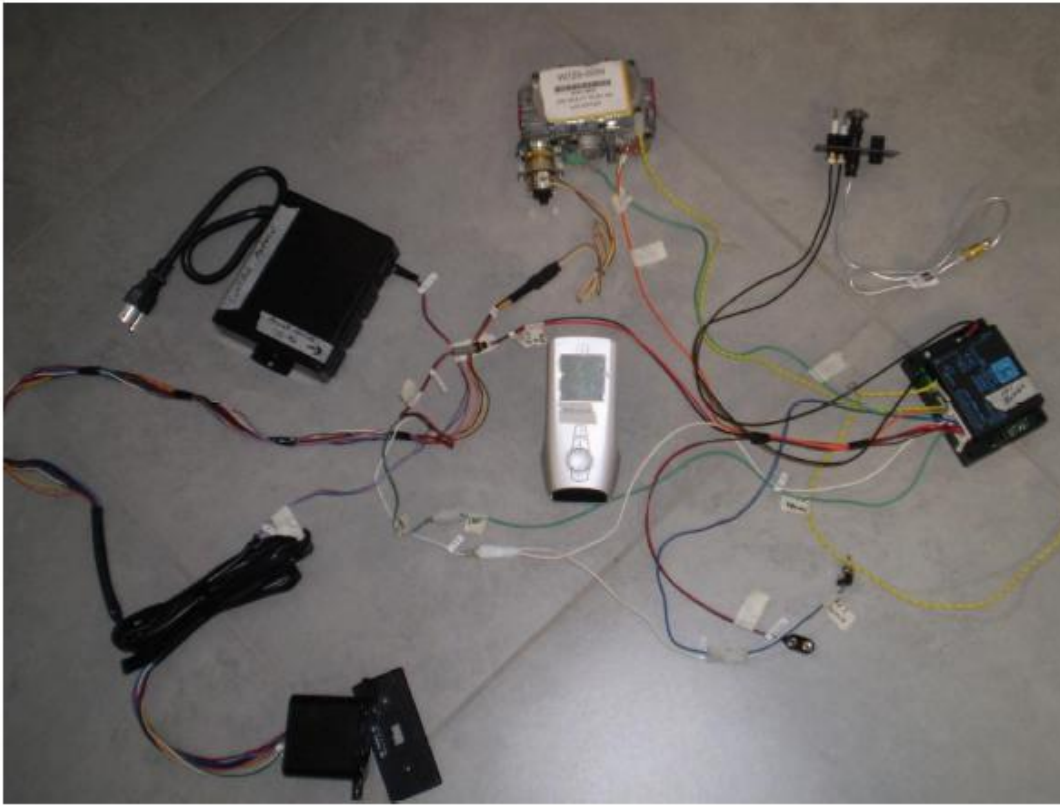

PROFLAME – S.I.T. VALVE with STEPPER MOTOR WIRING DIAGRAM

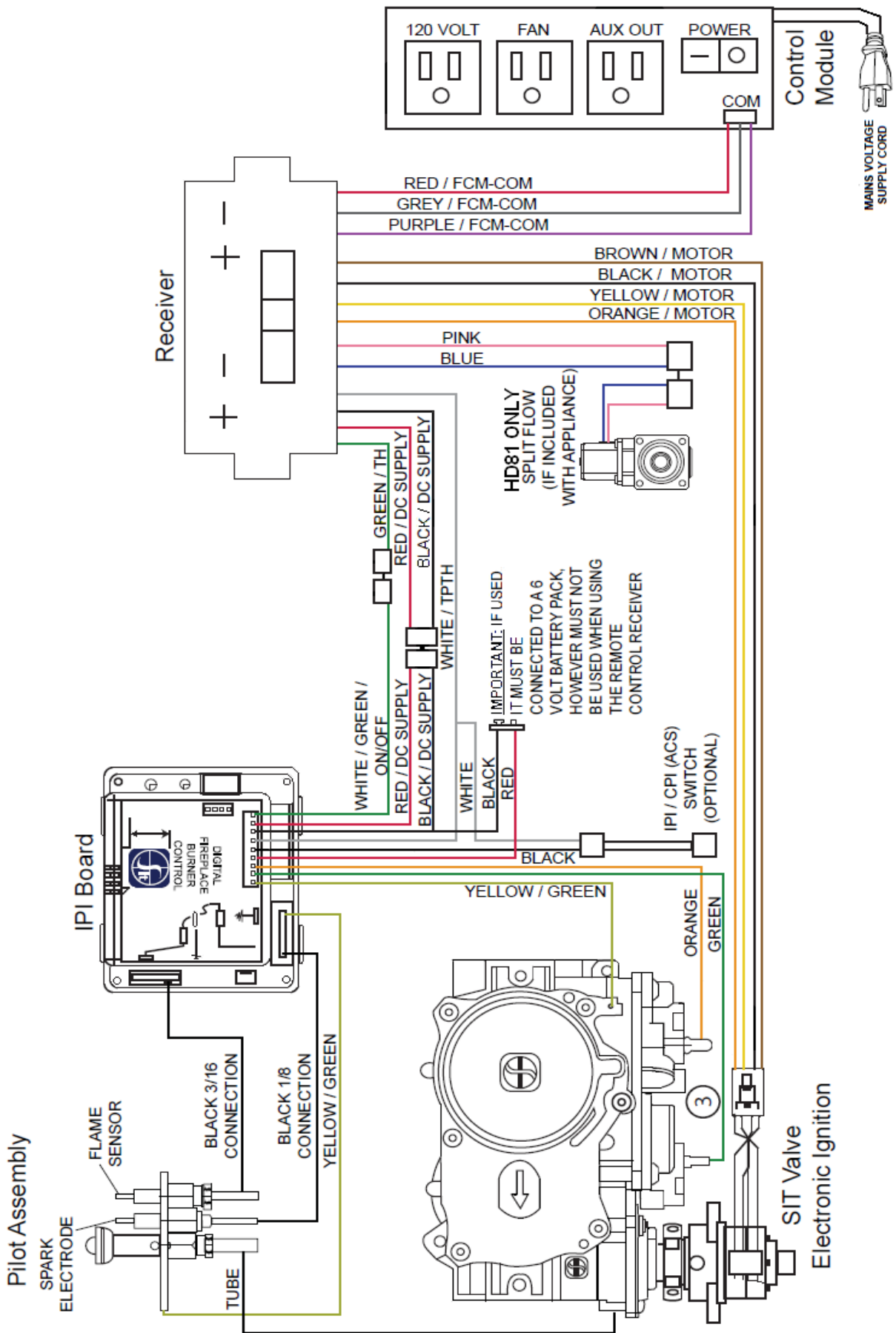

Troubleshooting: S.I.T. Valve w/Stepper Motor Electronic Ignition Units Pilot Not Sparking And / Or Lighting Flowchart

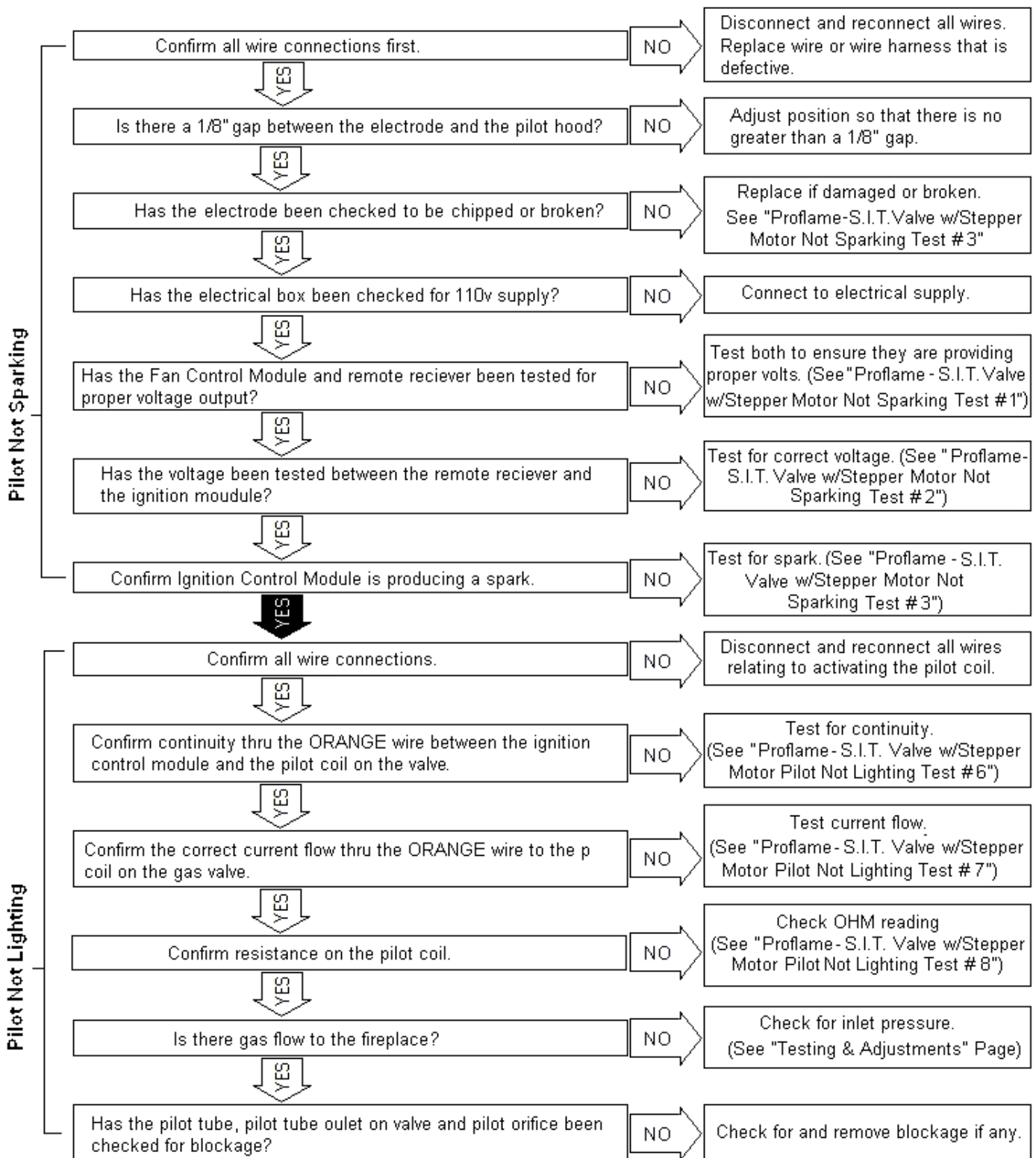

PROFLAME – S.I.T. VALVE with STEPPER MOTOR ELECTRONIC IGNITION NOT SPARKING DIAGNOSTICS TEST

NOTE: BEFORE STARTING THIS TEST CONFIRM THAT ALL WIRE CONNECTIONS ARE GOOD

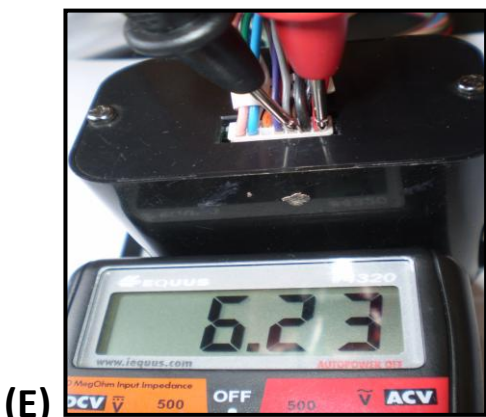
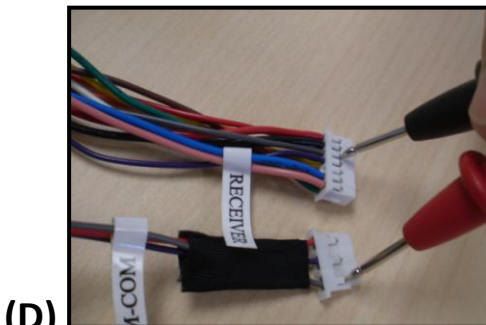
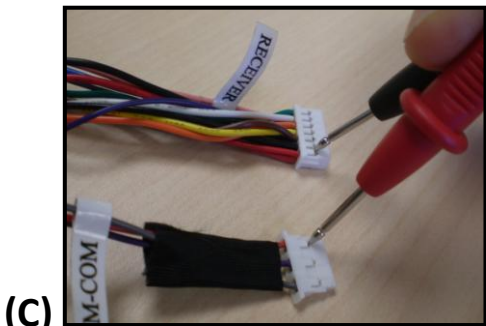
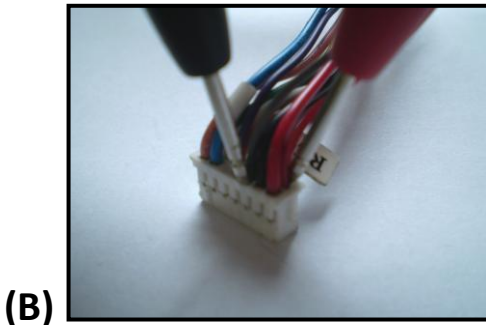
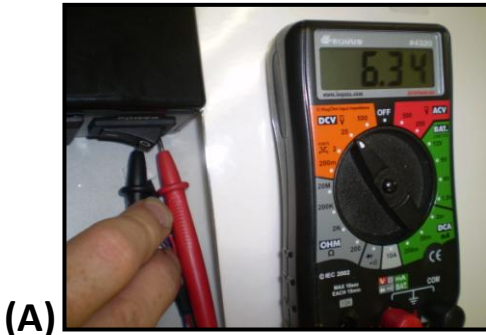

(E)

TEST #1- Test that there is power being supplied at the 2 main sources.

STEP #1- Confirm there is 110 AC volts at the plug in receptacle on the fireplace. Confirm there is 6.0 to 7.0 DC volts being supplied from the fan control module thru the pins that the thin RED and GREY wire on the connecting wire harness to the remote receiver connect to (A).

If "YES", go to STEP #2.

If "NO", replace fan control module.

STEP #2- Check the other end of the wire harness to ensure that there is 6.0 to 7.0 volts going thru the thin RED and GREY wires (B).

If "YES", go to STEP #4.

If "NO", replace wire harness.

STEP #3- Confirm continuity of the thin Red and GREY wires on the Remote receiver wire harness. See picture (C) and (D).

If "YES", confirm wire connections.

If "NO", replace remote receiver wire harness.

STEP #4- Attach wire harness to remote receiver (double check that the wire harness is plugged in securely at both ends), and test the thicker RED and BLACK wire to ensure that you are getting 6.0 to 7.0 volts (E).

If "Yes", go to TEST #2 on the next page.

If "NO", go to STEP #5.

STEP #5 – Confirm the lower 2 left pin connections that match up to the thicker red and black wire from the wire harness plug on the remote receiver is showing between 6.0 to 7.0DC volts. Slide the receiver to the ON position and test as shown in picture (F).

If "YES" go to TEST #2.

If "NO", replace remote receiver.



(F)

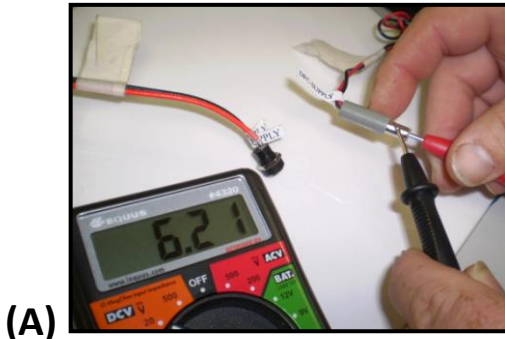

(A)

TEST #2- Confirm for proper connection at all wire connections between the receiver and the ignition module. Confirm there is 6.0 to 7.0 DC volts power supply from the receiver at both test points as shown in the pictures (A) & (B).

STEP #1- Insert RED positive test probe into the female connector and touch the outside of the connector with the BLACK test probe (6.0 to 7.0 DC volts). See picture (A).

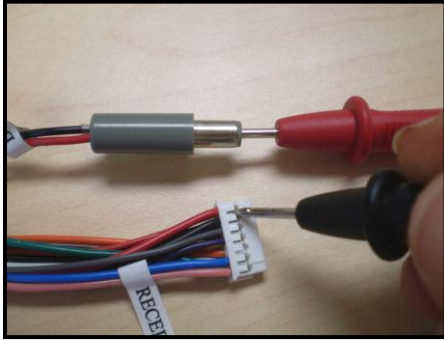

(B)

If "YES", go to STEP #2

If "NO", Confirm continuity for both the thicker RED and BLACK wire on the remote receiver wire harness,(see picture (B) for red wire & picture (C) for black wire.

If "YES" to both wires confirm wire harness connection to remote receiver. Go to STEP #2

If "NO" to either wire. Replace wire harness

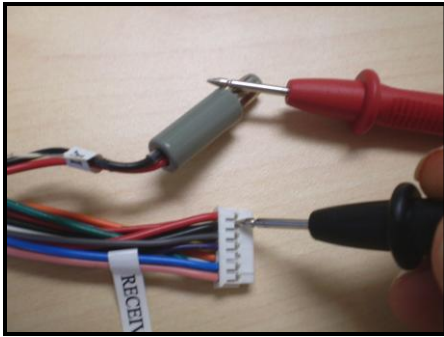

(C)

STEP #2-Reconnect both the male and female DC wire plugs. Insert the RED positive test probe into the wire harness plug at the Red wire location. Insert the BLACK negative test probe into the wire harness plug at the BLACK wire connection (6.0 to 7.0 volts). See picture (D)

If "YES", go to TEST #3

If "NO", go to STEP #3.

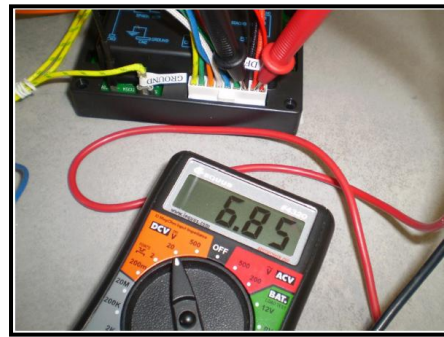

(D)

STEP #3-Confirm continuity for both the thicker RED and BLACK wire on the ignition control module wire harness. See picture (E) for red wire, and picture (F) for black wire.

If "YES", go to TEST #6

If "NO", replace ignition control wire harness.

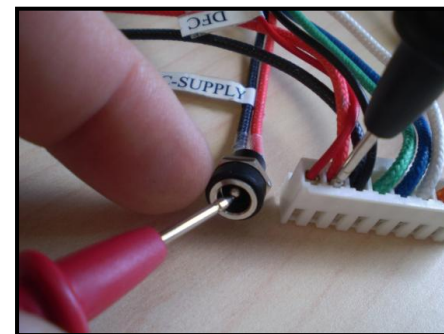

(E)

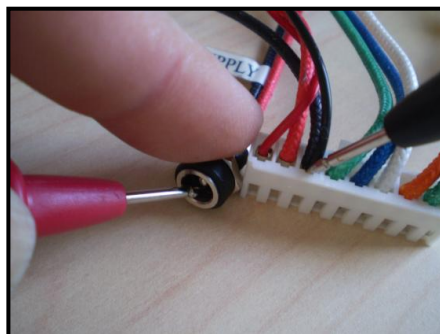

(F)

TEST #3 –Confirm that the igniter wire and the grounding wire is securely connected to the ignition module and that the grounding wire is secured to the fireplace. See Picture (A).

If “NO”, ensure good connection.

If “YES”, go to STEP #1.

STEP #1-Remove igniter wire and hold it about 1/8th inch off the igniter tab (see picture (B)), and activate the fireplace to start ignition.

If “YES”, go to STEP #2.

If “NO”, replace ignition control module.

FOR LHD50, IR3N, XIR3N, IR3G & XIR4N ONLY

“For HD81 See following page for extended spark testing TEST #4”

STEP #2-Check that ceramic electrode and the pilot hood has a 1/8th inch gap between.

If “YES”, replace ceramic electrode.

If “NO”, adjust gap to 1/8th inch.

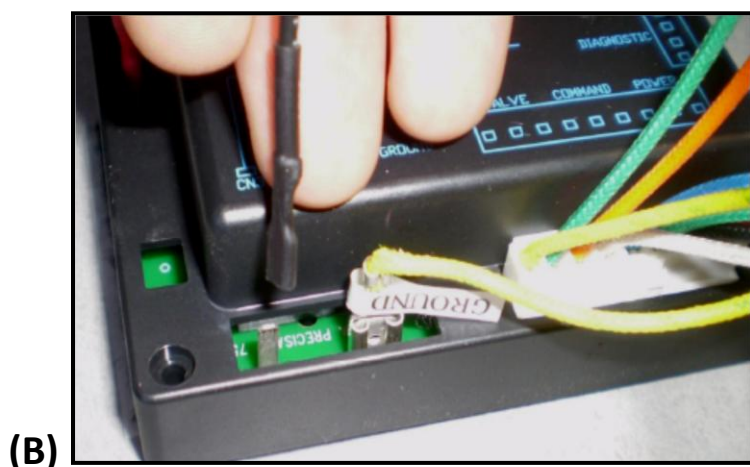
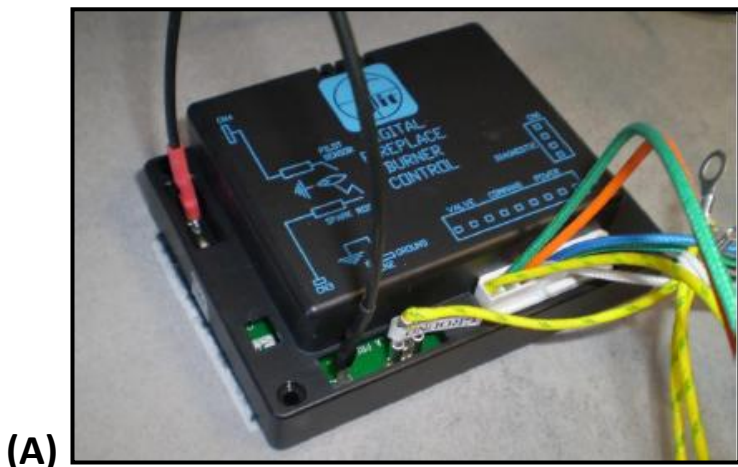

HD81 Extended Spark Testing.

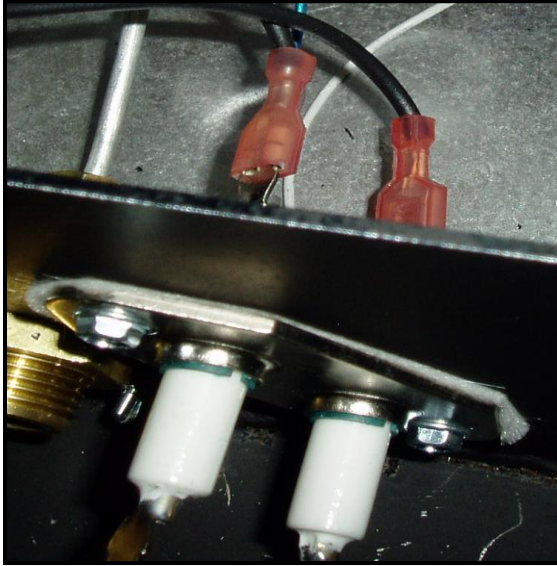

(A)

TEST #4 –Confirm spark to bulkhead from ignition wire.

STEP #1-Remove igniter wire (1/4" connector) from bulkhead and hold it about 1/8th inch off the bulkhead igniter tab and activate the fireplace to start ignition **(A)**.

If "YES", go to TEST #4.

If "NO", test the igniter wire for continuity. Replace if not good.

If "YES", go to STEP #2.

STEP #2-Check the ground wire for continuity and good grounding. Replace if not good

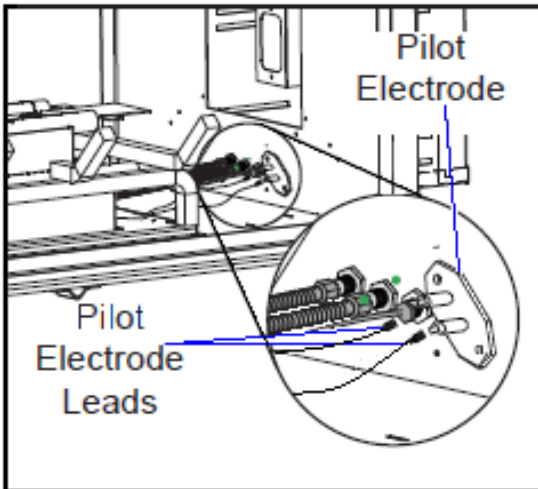

(B)

TEST #5-Confirm spark is transferring through the bulkhead.

STEP #1- Ensure that the 1/4" flag on the electrode lead is attached to the 1/4" bulkhead spade, and the 3/16" flag is on the 3/16" bulkhead spade.

If "NO", ensure correct connection.

If "YES" go to STEP #2

STEP #2-Check for spark coming thru the bulkhead by removing the igniter wire 1/4" flag off the bulkhead 1/4" spade and hold it 1/8th inch off the spade and active the pilot to light.

If "NO", replace the bulkhead.

If "YES" go to STEP #3.

STEP #3-Check that ceramic electrode and the pilot hood has a 1/8th inch gap between them.

If "YES", replace ceramic electrode.

If "NO", adjust gap to 1/8th inch.

PROFLAME - S.I.T. VALVE with STEPPER MOTOR ELECTRONIC IGNITION PILOT NOT LIGHTING DIAGNOSTICS TEST

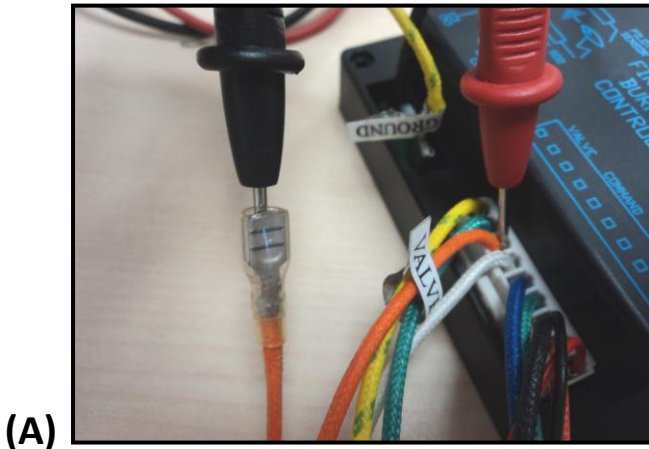

TEST #6 – Confirm continuity thru the ORANGE wire from the Ignition control wire harness to the gas valve pilot coil **(A)**.

STEP #1 – Place the RED probe lead into where the orange wire come out of the wire harness connection, and place the BLACK probe lead into the end of the orange wire tab connection.

If “YES” go to STEP #7

If “NO”, replace wire harness.



TEST #7 – Confirm the current flow thru the ORANGE wire from the ignition control module to the gas valve pilot coil.

STEP #1 – Set your multi meter to 20 DCA mA. Take the BLACK probe lead connect it to the end of the orange wire from the ignition control module. Take the RED probe lead and hold it against the red pilot coil tab on the gas valve **(B)**.

Activate the unit to start up. Once it starts sparking you should be reading a cycling amperage of 1.50 DCmA to 19+ DCmA

NOTE: The standard running current after approximately 30 seconds to a minute of the pilot operating. You should be getting between 1.5 to 2.0 DCA milliamps.

If “NO” – Replace the ignition control module.

If “YES” – go to TEST #8.

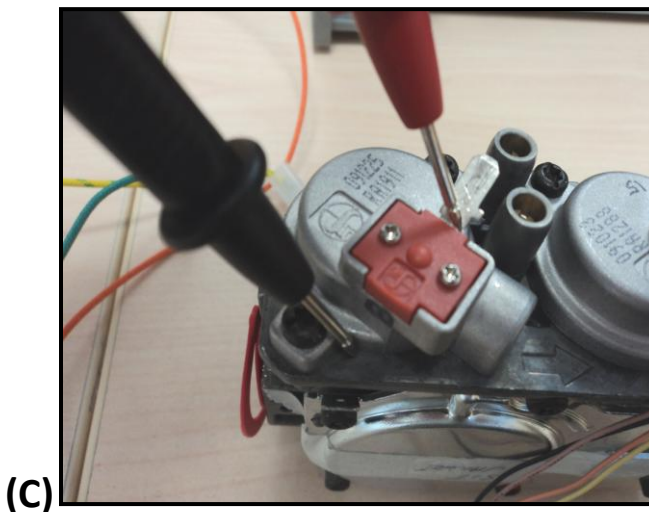

TEST #8 – Set your multi meter to 200 OHMS and place the tip of the red meter lead on the red pilot coil tab on the gas valve. Place the tip of the black meter lead to the body of the valve **(C)**. You should be getting between 345 to 349 OHMS.

If “NO”, replace gas valve.

If “YES”, check inlet pressure test port for gas flow to Valve (see “Testing & Adjustments Section”).

If there is gas flow, check for blockage in pilot orifice, pilot tube, and pilot connection port on valve. Remove blockage where found.

If no gas to valve, inspect supply lines and shut off valves.

Troubleshooting: S.I.T. Valve w/Stepper Motor Electronic Ignition Units Burner Not Lighting Flowchart

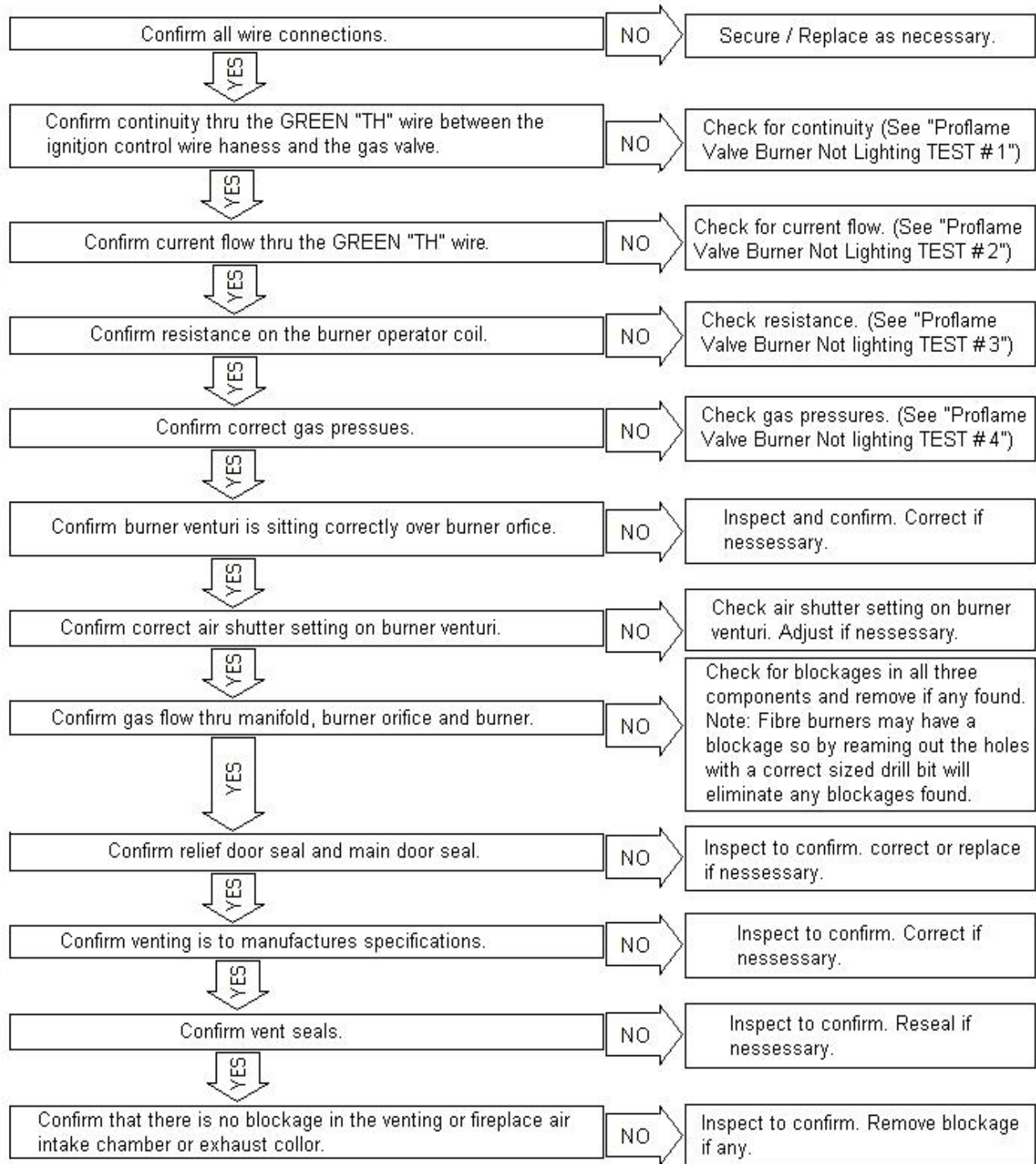

PROFLAME – S.I.T. VALVE with STEPPER MOTOR ELECTRONIC IGNITION BURNER NOT LIGHTING DIAGNOSTICS TEST

NOTE: BEFORE STARTING THIS TEST CONFIRM THAT ALL WIRE CONNECTIONS ARE GOOD

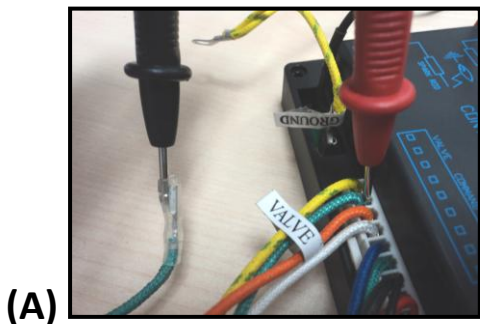

TEST #1 – Confirm continuity thru the GREEN wire from the Ignition control wire harness to the gas valve pilot coil (A).

NOTE: Pilot flame must be running in order to perform this test.

STEP #1 – Place the RED probe lead into where the green wire comes out of the wire harness connection, and place the BLACK probe lead into the end of the green wire tab connection.

If “YES” go to TEST #2

If “NO”, replace wire harness.



TEST #2 – Confirm the current flow thru the GREEN wire from the ignition control module to the gas valve pilot coil.

STEP #1 – Set your multi meter to DCA mA. Take the BLACK probe lead and contact it to the end of the green wire from ignition control module wire harness. Take the RED probe lead and hold it against the green pilot coil tab on the gas valve (B). Activate the unit to start up. It will take approximately 30 seconds to a minute for the current to stabilize. You should be getting between 1.5 to 2.0 DCA milliamps.

If “NO” – Replace the ignition control module.

If “YES” – go to TEST #3.

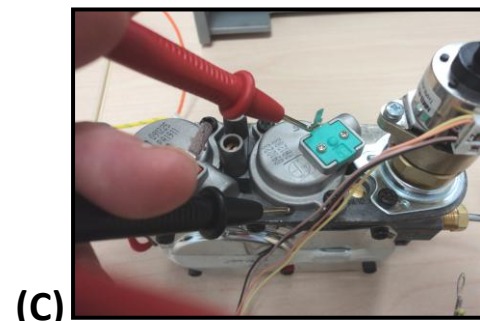

TEST #3 – Set your multi meter to 200 OHMS and place the tip of the red meter lead on the green burner operator coil tab on the gas valve. Place the tip of the black meter lead to the body of the valve (C). You should be getting between 328 to 332 OHMS.

If “NO”, replace gas valve.

If “YES”, go to TEST # 4.

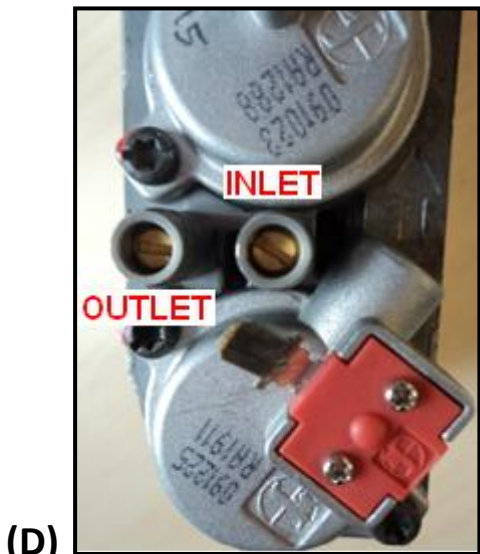

TEST #4 – Confirm correct pressure to and out of gas valve. (D)

STEP #1 – Check inlet pressure (IN) should be 7”wc for natural gas and 11”wc to 13”wc for propane.

If “NO”, check supply lines and meter (NG)/regulator (LP)

If “YES”, Go to STEP #2.

STEP #2 – Check outlet pressure (OUT) should be 3.5”wc on high for natural gas and 10”wc for propane.

If “NO”, confirm if a conversion was done that it was done correctly. If it was done correctly, then replace gas valve.

If “YES”, check for blockage in burner orifice, and manifold tube. Remove blockage where found.

S.I.T. MANUAL VALVE ELECTRONIC SYSTEM

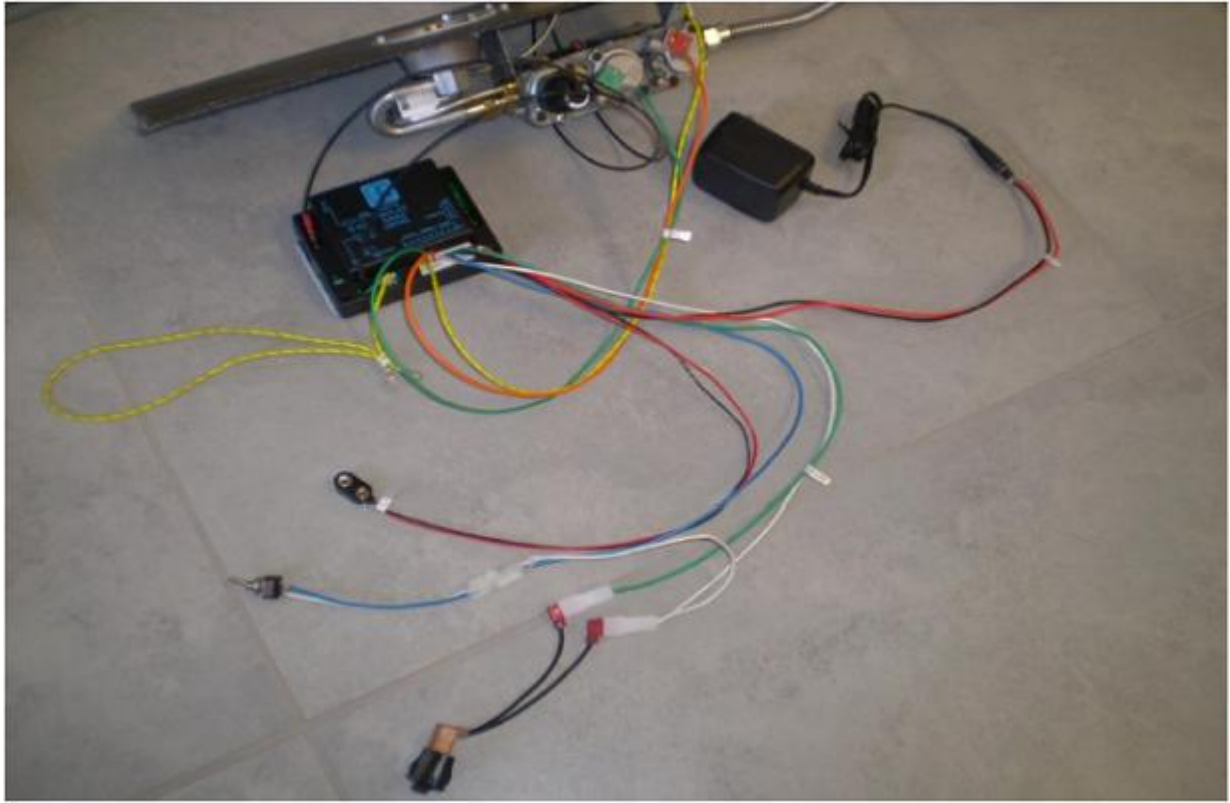

S.I.T. ELECTRONIC VALVE



PILOT ASSEMBLY

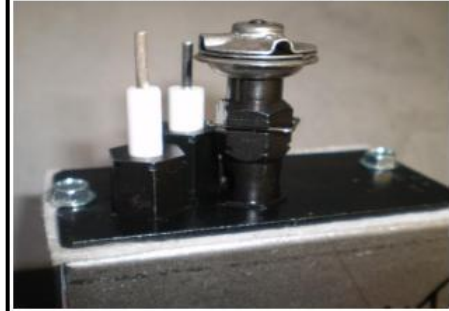

S.I.T. CONTROL MODULE

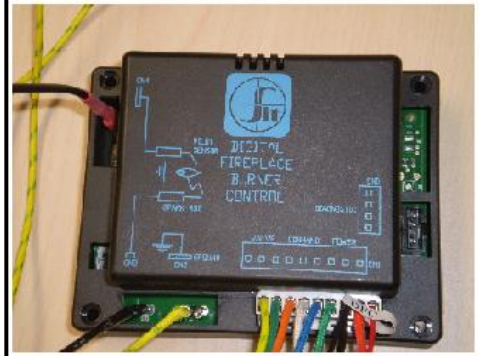

7 V/DC TRANSFORMER



S.I.T. MANUAL VALVE ELECTRONIC WIRING DIAGRAM

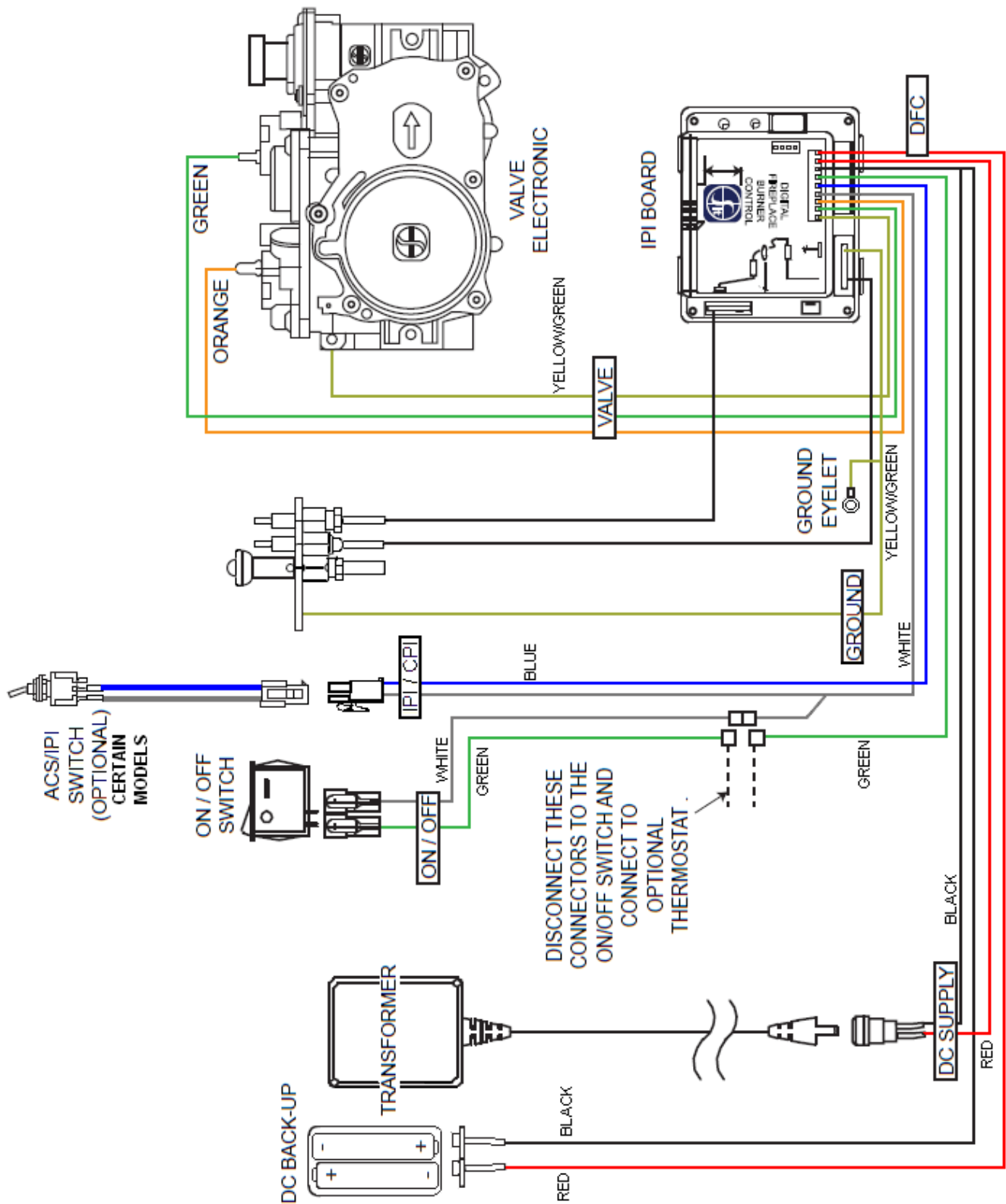

Troubleshooting: S.I.T. Manual Valve Electronic Ignition Units Pilot Not Sparking And / Or Lighting Flowchart

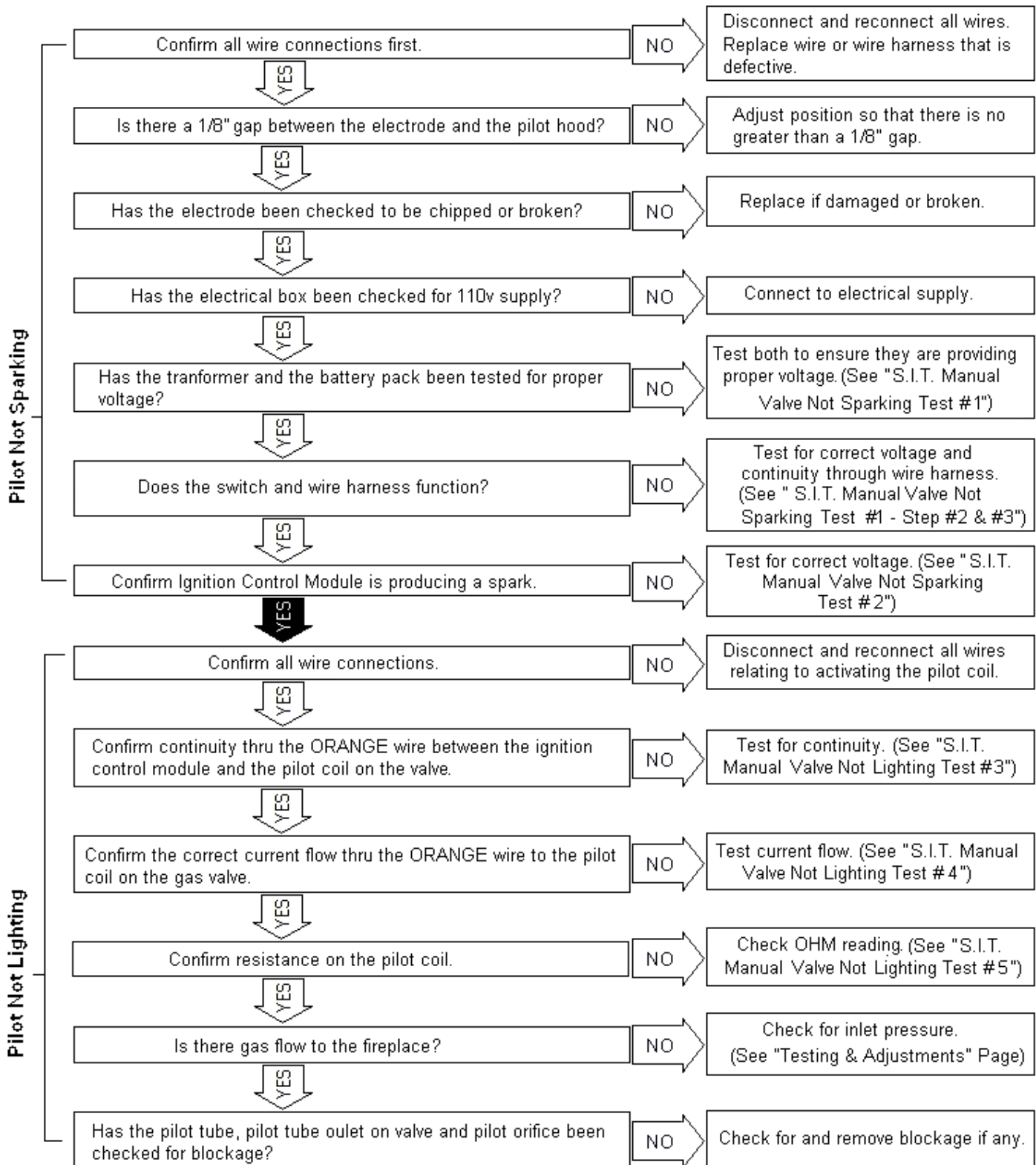

S.I.T. MANUAL VALVE ELECTRONIC IGNITION NOT SPARKING DIAGNOSTICS TEST

NOTE: BEFORE STARTING THIS TEST CONFIRM THAT ALL WIRE CONNECTIONS ARE GOOD

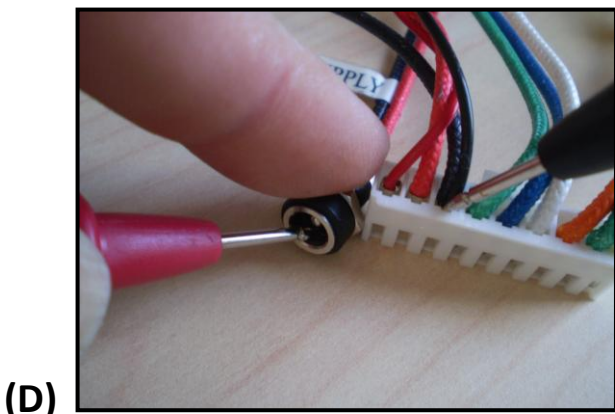
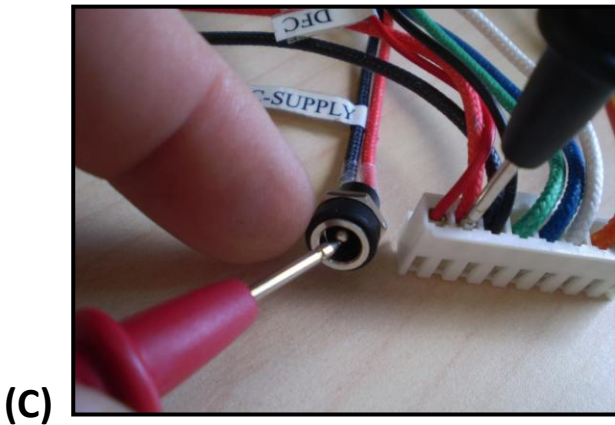
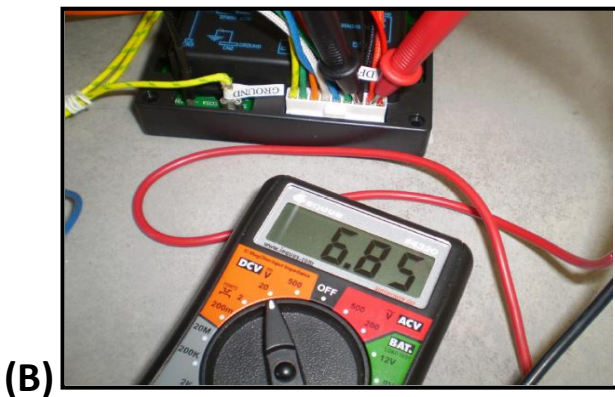
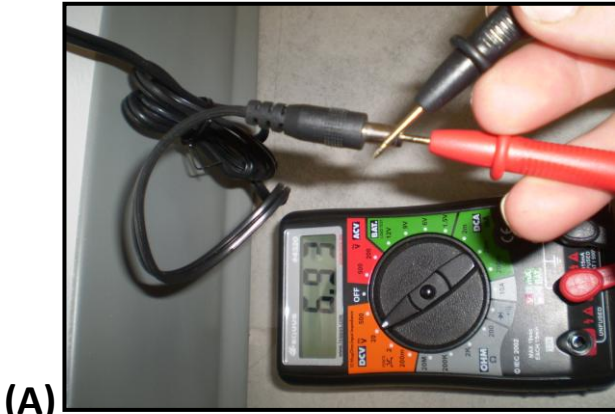

TEST #1 - Confirm that there is between 6.0 to 7.0DC volts power supply from the receiver at both test points, and confirm all wire harness connections

STEP #1-Insert RED positive test probe into the female connector and touch the outside of the connector with the BLACK test probe (6.0 to 7.0 DC volts). See picture (A).

If "NO", replace transformer.

If "YES", go to STEP #2.

STEP #2-Plug in the transformer and connect it to the wire harness. Insert the RED positive test probe into the wire harness plug at the Red wire location. Insert the BLACK test probe into the wire harness plug at the BLACK wire connection. You should get between 6.0 to 7.0DC volts. See picture (B)

If "NO", go to STEP #3.

If "YES", go to TEST #2.

STEP #3-Confirm continuity for both the thicker RED and BLACK wire on the ignition control module wire harness. See picture (C) for red wire, and picture (D) for black wire.

If "YES", confirm wire connections and go to TEST #2

If "NO", replace ignition control wire harness.

NOTE: If using only the battery backup, check that you have 1.5 volts coming from each of the 4 AA batteries, and that you have between 6.0 to 7.0DC volts out of the battery pack connection.

S.I.T. MANUAL VALVE ELECTRONIC IGNITION NOT SPARKING DIAGNOSTICS TEST-continued

TEST #2 –Confirm that the igniter wire and the grounding wire is securely connected to the ignition module and that the grounding wire is secured to the fireplace. See Picture (A).

If “NO”, ensure good connection.

If “YES”, go to STEP #1.

STEP #1-Remove igniter wire and hold it about 1/8th inch off the igniter tab and activate the fireplace to start ignition (B).

If “YES”, go to STEP #2.

If “NO”, replace ignition control module.

STEP #2-Check that ceramic electrode and the pilot hood has a 1/8th inch gap between.

If “YES”, replace ceramic electrode.

If “NO”, adjust gap to 1/8th inch.

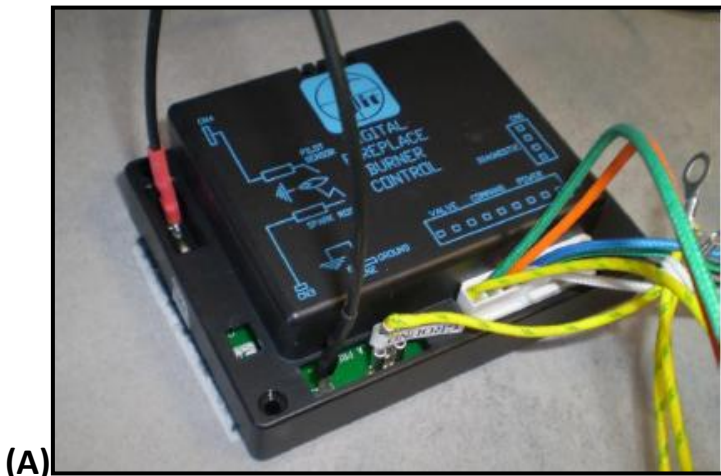

S.I.T. MANUAL VALVE ELECTRONIC IGNITION PILOT NOT LIGHTING DIAGNOSTICS TEST

(A)

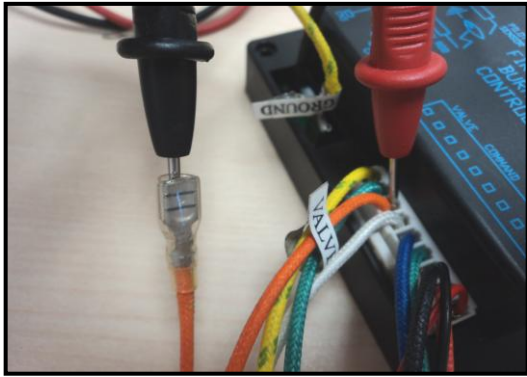

TEST #3 – Confirm continuity thru the ORANGE wire from the Ignition control wire harness to the gas valve pilot coil.

STEP #1 – Place the RED probe lead into where the orange wire come out of the wire harness connection, and place the BLACK probe lead into the end of the orange wire tab connection **(A)**.

If “YES” go to STEP #7

If “NO”, replace wire harness.

(B)



TEST #4 – Confirm the current flow thru the ORANGE wire from the ignition control module to the gas valve pilot coil.

STEP #1 – Set your multi meter to 20 DCA mA. Take the BLACK probe lead connect it to the end of the orange wire from the ignition control module. Take the RED probe lead and hold it against the red pilot coil tab on the gas valve **(B)**.

Activate the unit to start up. Once it starts sparking you should be reading a cycling amperage of 1.50 DCmA to 19+ DCmA

NOTE: The standard running current after approximately 30 seconds to a minute of the pilot operating. You should be getting between 1.5 to 2.0 DCA milliamps.

If “NO” – Replace the ignition control module.

If “YES” – go to TEST #8.

(C)

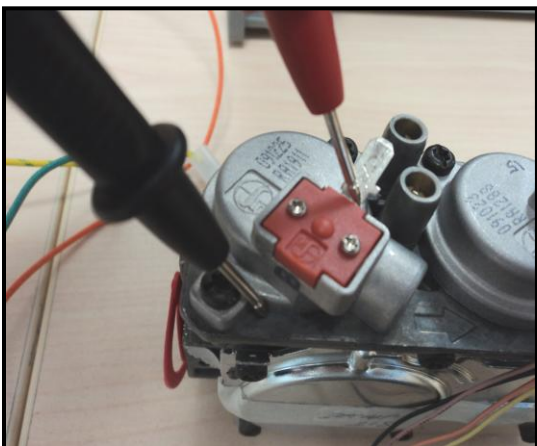

TEST #5 – Set your multi meter to 200 OHMS and place the tip of the red meter lead on the red pilot coil tab on the gas valve. Place the tip of the black meter lead to the body of the valve **(C)**. You should be getting between 332 to 336 OHMS.

If “NO”, replace gas valve.

If “YES”, check inlet pressure test port for gas flow to Valve (see “Testing & Adjustments Section”).

If there is gas flow, check for blockage in pilot orifice, pilot tube, and pilot connection port on valve. Remove blockage where found.

If no gas to valve, inspect supply lines and shut off valves.



Troubleshooting: S.I.T. Manual Valve Electronic Ignition Units

Burner Not Lighting Flowchart

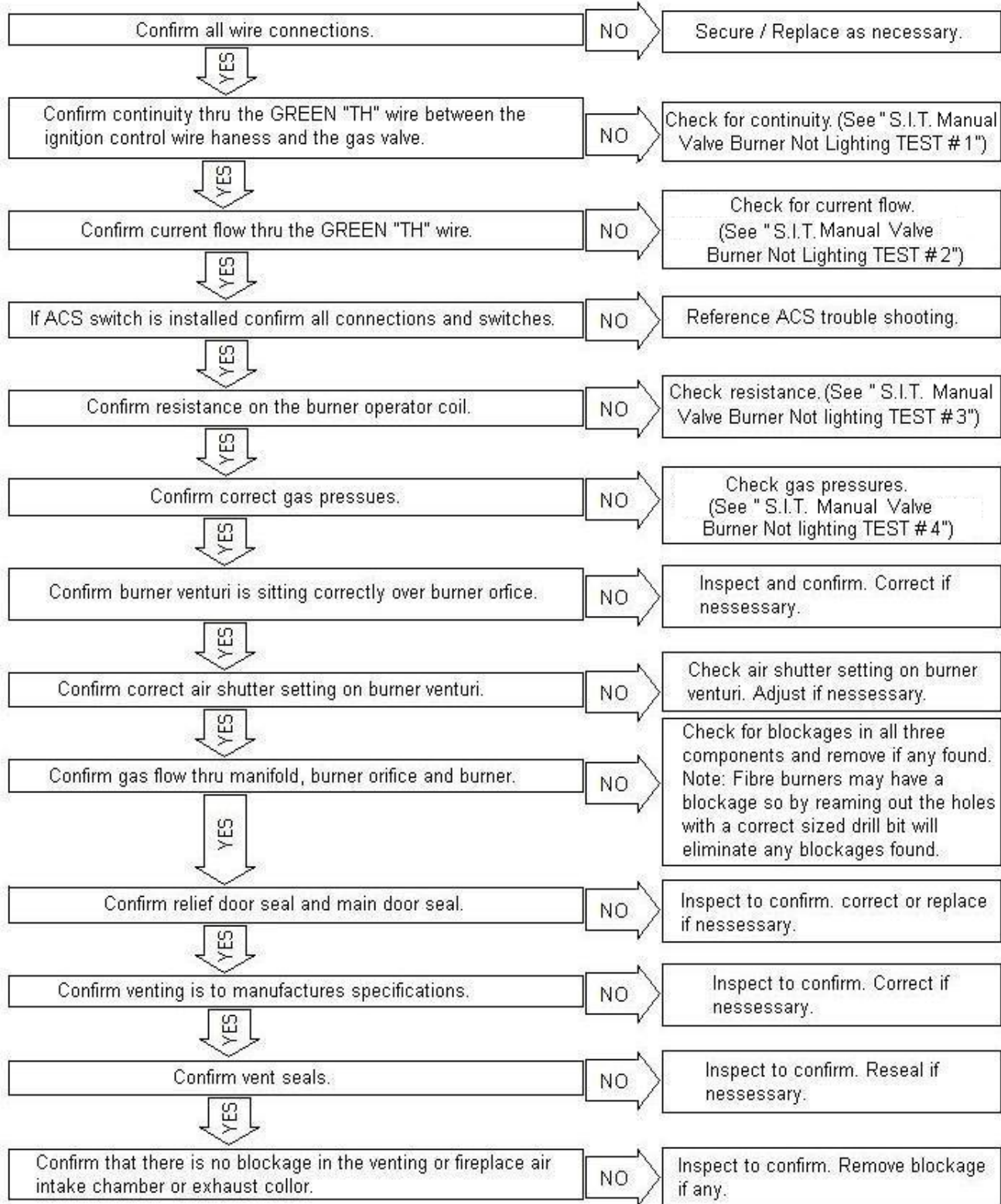

S.I.T. MANUAL VALVE ELECTRONIC IGNITION BURNER NOT LIGHTING DIAGNOSTICS TEST

NOTE: BEFORE STARTING THIS TEST CONFIRM THAT ALL WIRE CONNECTIONS ARE GOOD

(A)

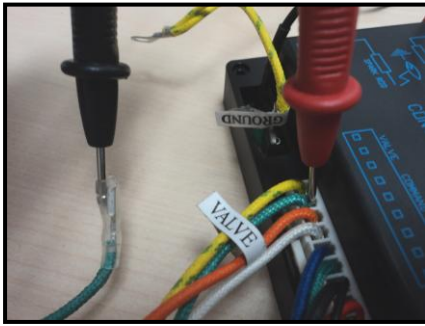

TEST #1 – Confirm continuity thru the GREEN wire from the Ignition control wire harness to the gas valve pilot coil (A).

STEP #1 – Place the RED probe lead into where the green wire comes out of the wire harness connection, and place the BLACK probe lead into the end of the green wire tab connection.

If “YES” go to TEST #2

If “NO”, replace wire harness.

(B)



TEST #2 – Confirm the current flow thru the GREEN wire from the ignition control module to the gas valve burner coil.

NOTE: Pilot flame must be operational in order to perform this test

STEP #1 – Set your multi meter to DCA mA. Take the BLACK probe lead and contact it to the end of the green wire from ignition control module wire harness. Take the RED probe lead and hold it against the green pilot coil tab on the gas valve (B).

Activate the unit to start up. It will take approximately 30 seconds to a minute for the current to stabilize. You should be getting between 1.5 to 2.0 DCA milliamps.

If “NO” – Replace the ignition control module.

If “YES” – go to TEST #3.

(D)

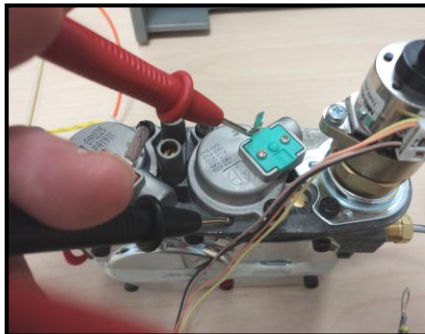

TEST #3 – Set your multi meter to 200 OHMS and place the tip of the red meter lead on the green burner operator coil tab on the gas valve. Place the tip of the black meter lead to the body of the valve (D). You should be getting between 330 to 334 OHMS.

If “NO”, replace gas valve.

If “YES”, go to TEST #4.

(E)

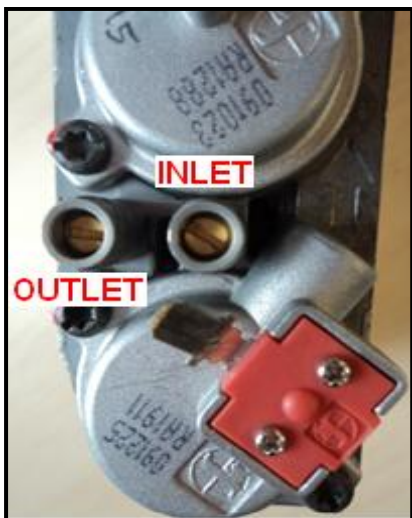

TEST #4 – Confirm correct pressure to and out of gas valve.

STEP #1 – Check inlet pressure (IN) should be 7”wc for natural gas and 11”wc to 13”wc for propane.

If “NO”, check supply lines and meter (NG)/regulator (LP)

If “YES”, Go to STEP #2.

STEP #2 – Check outlet pressure (OUT) should be 3.5”wc on high for natural gas and 10”wc for propane.

If “NO”, confirm if a conversion was done that it was done correctly. If it was done correctly, then replace gas valve.

If “YES”, check for blockage in burner orifice, and manifold tube. Remove blockage where found.